

Dose Rate Meter 6150AD

Operating Manual
for the
Dose Rate Meter 6150AD
referring to these models:
6150AD1 to 6150AD6,
6150AD1/H to 6150AD6/H,
6150AD1/E to 6150AD6/E.



Contents I

1. Application	1
2. 6150AD Models	1
3. Construction	6
3.1 Housing	6
3.2 Location of Detector	6
3.3 Display	6
3.4 Speaker	7
3.5 Keys	7
3.6 Probe Socket	7
4. Functions	8
4.1 Dose Rate Measurement	8
4.2 Audible Single Pulse Detection	8
4.3 Dose Rate Alarm	8
4.4 Dose Rate Mean Value	9
4.5 Dose Rate Maximum Value	10
4.6 Dose	10
4.7 Non-volatile Dose Memory (6150AD3/4/5/6 only)	11
4.8 Dose Alarm (6150AD3/4/5/6 only)	12
4.9 Checking the Battery	13
4.10 Calibration	13
4.11 Operation with Probes	13
5. Operation	14
5.1 Probe Connector Locking	14
5.2 Replacing the Battery	14
5.3 Automatic Battery Warning	14
5.4 Switching On and Off, Erase Function of the On/off Key	15
5.5 Illumination Key	16
5.6 Signal Key (Loudspeaker Key)	16
5.7 Functions called by the Function Key (Arrow Key)	16
5.7.1 Indication of Dose Rate	17
5.7.2 Indication of Dose Rate Mean Value	18
5.7.3 Indication and Selection of Dose Rate Alarm Threshold	18
5.7.4 Indication of Dose Rate Maximum Value	19
5.7.5 Indication of Dose	19
5.7.6 Indication and Selection of Dose Alarm Threshold (6150AD3/4/5/6 only)	20
5.7.7 Indication of Battery Voltage	20
5.7.8 Indication of Calibration Parameters	21

Contents II

6. Display Ranges and Display Formats	22
6.1 Dose Rate	22
6.2 Dose Rate Mean Value	24
6.3 Dose Rate Alarm Threshold	25
6.4 Dose Rate Maximum Value	25
6.5 Dose	26
6.6 Dose Alarm Threshold (6150AD3/4/5/6 only)	26
7. Measuring Ranges	27
7.1 Dose Rate Measuring Ranges	27
7.2 Dose Measuring Ranges	28
8. Fixed Alarm Thresholds	28
8.1 Dose Rate Alarm Thresholds	29
8.2 Dose Alarm Thresholds (6150AD3/4/5/6 only)	29
9. Energy Dependence and Directional Dependence	30
9.1 6150AD1, 6150AD3, 6150AD5	31
9.2 6150AD1, 6150AD3, 6150AD5 (/H and /E models)	32
9.3 6150AD2, 6150AD4, 6150AD6	33
9.4 6150AD2, 6150AD4, 6150AD6 (/H and /E models)	34
10. Time Constant and Standard Deviation	35
11. Radiological Check	36
12. Programming the 6150AD3/4/5/6	38
12.1 Individual Dose Rate Alarm Threshold	39
12.2 Individual Dose Alarm Threshold	40
12.3 Post-alarm Increment for Dose Alarm	40
12.4 Enabling or Disabling non-volatile Dose Storage	41
12.5 Resetting to Factory Setting	41
13. Wall Holders (Accessories)	42
14. Technical Data	43
14.1 6150AD	43
14.2 Source Holder 761.1	45
14.3 Wall Holder 761.8	45
14.4 Wall Holder with AC Adapter 761.13	46
14.5 Serial Interface of the 6150AD	46
Appendix: 6150AD3/4/5/6 Programming Flow Chart	48



Daimlerstrasse 27
D-68526 Ladenburg

Telefon +49(0)6203-9503-00
Telefax +49(0)6203-9503-29

<http://www.automess.de>
eMail: info@automess.de

USt.-ID-Nr. / VAT ID No.
DE 144 458 420

1. Application

The 6150AD is a portable, battery operated dose rate meter to measure photon radiation (gamma and X radiation). A built-in GM counting tube serves as the detector.

NOTE! The internal counting tube is operated from a 500 V high voltage! Touching that high voltage may be hazardous to your health, so never try to open or repair the instrument!

The 6150AD comes in various models that differ by the type of built-in GM tube and by the scope of functions. Section 2 summarizes the various models.

As implied by the letters »AD« in its name, the 6150AD displays dose rate in both analog and digital form. Furthermore, it permanently measures dose rate mean value, dose rate maximum value, and accumulated dose. You may look at any of those values at any time just by pressing a key. At low levels, the dose rate mean value permits much more accurate readings than the normal dose rate indication with its statistical fluctuations would allow. This is particularly useful when measuring low contamination values with external probes.

All models have alarm thresholds for dose rate, some models also for dose. Some models have programmable thresholds that allow you to set alarm thresholds to any value within the instrument's range. All models support audible single pulse detection.

Particular advantages of the 6150AD are its robust and waterproof construction, and its simple operation. Automatic range selection and clear LCD indications help to avoid operational errors.

The 6150AD supports various probes for various applications: measurement of low or high dose rate photon radiation, detection of alpha and beta radiation, measurement of contamination of solids or liquids. Therefore, the 6150AD - with an external probe if necessary - is well suited for many radiation protection measuring tasks.

This manual shall not discuss the radiological features of the probes; there are separate manuals for the probes. This manual only describes those probe features that are determined by the 6150AD and not by the probe itself. Among the features determined by the 6150AD are, for example, ranges and alarm thresholds of the probes.

One pin of the probe connector is a serial interface that allows to read and process dose rate by a computer.

2. 6150AD Models

The various models reflect the instrument's history. Serial production started in 1986 with models 6150AD1 and 6150AD2. These two models differ by the type of built-in counting tube and therefore by range. The 6150AD1 has a smaller, that is less sensitive tube (type ZP1310) covering dose rates up to 1 Sv/h. The 6150AD2 has a larger tube (type ZP1200) which only covers dose rates up to 10 mSv/h, but which is better suited for low levels because of its higher sensitivity. The more favourable model depends on the application. If dose rates above 10 mSv/h are unlikely to occur, the 6150AD2 is preferred, otherwise the 6150AD1. As far as operation and function are concerned, both models are completely equal.

During years of experience with the models 6150AD1/2 some users requested additional functions such as:

- Protection against unintentional switching off,
- Non-volatile storage of the dose measured with the internal tube,
- Dose alarm,
- Programmable alarm thresholds for dose and dose rate,
- Better resolution (more places after the decimal point) when indicating dose, alarm threshold, and so on.

We met these requirements by introducing a new hardware release and extending the microprocessor's program. However, additional functions will inevitably make operating the instrument a little more complex. Users who do not need the additional functions may prefer a simple model. For those users we decided to continue the models 6150AD1/2, and to create »more intelligent« successors called 6150AD3 and 6150AD4. The 6150AD3/4 models are in the market since 1990. The 6150AD3 has the same hardware and the same GM tube as the 6150AD1, which means it is the more intelligent successor of the 6150AD1. Internally the only difference between a 6150AD3 and a 6150AD1 is the contents of its program memory (EPROM). In the same sense the 6150AD4 is the successor of the 6150AD2.

In 1994 the Scintillator Probe 6150AD-b came on the market. This probe required another modification of the 6150AD for the following reason: as mentioned earlier, the 6150AD will automatically select ranges and units when connecting an external probe. For this purpose the 6150AD needs certain information about each probe type. The previous models 6150AD1-4 do not know the new probe type; they indicate »Err ext« when connecting a 6150AD-b probe or some other unknown probe type. Therefore we created the models 6150AD5 and 6150AD6, which will also identify the 6150AD-b probe. We also used this occasion to add as a new function the indication of the relative standard deviation of dose rate mean value. Again, the 6150AD5/6 models differ from their predecessors 6150AD3/4 only by contents of the program memory.

Introducing the models 6150AD5/6 made the models 6150AD3/4 more or less unnecessary. Their function is almost equal, and the additional ability of the 6150AD5/6 to identify the probe 6150AD-b is surely no drawback. When buying a new instrument (without the need to recognize the 6150AD-b probe), the only reason to prefer the 6150AD3/4 to the 6150AD5/6 would be that the user already has 6150AD3/4 models and wishes to keep his variety of models as small as possible. For this purpose the 6150AD3/4 is still available.

Next we have to discuss measuring quantity and unit. The 6150AD1/2 models are available in R(Roentgen) units (measuring quantity is Exposure Dose J_s) and in Sv(Sievert) units (measuring quantity is Photon Dose Equivalent H_x). Note that J_s can be converted to H_x according to

$$H_x [\text{Sv}] = 0.01 \text{ Sv/R} \cdot J_s [\text{R}]$$

independent of photon energy. This means that J_s and H_x are very close related quantities, they just differ by a factor of 100. Because this conversion is independent of energy, the 6150AD3/4/5/6 models allow the user to select one of the two units R and Sv. H_x was the legal quantity in Germany from 1986 to 2001; however, the quantity H_x was hardly accepted internationally.

In 2000, we created models for Ambient Dose Equivalent $H^*(10)$, which is also measured in Sv. This required modification of energy dependence, which means modification of energy compensation. The energy compensation is an alloy of heavy metals surrounding the counting tube. When replacing the energy compensation and re-calibrating any 6150AD1-6, the instrument will be suited for $H^*(10)$. All functions remain unchanged, even modifying the software (EPROM) is not absolutely necessary. However, software (EPROM) should also be adapted, since $H^*(10)$ models must no longer allow to switch the unit from Sv to R because this conversion is energy dependent.

If you feel confused that models for different quantities (H_x models and $H^*(10)$ models) use the same unit (Sv), keep in mind that a measuring *quantity* and its *unit* are different things. For example, think of an alternating current: it may be characterized by different quantities like peak value or root-mean-square value, which will have different values, although they are measured with the same unit (volts, amps). The same is true for a radiation field: you may measure its quantity as H_x or as $H^*(10)$, and you will get different results, although both are measured in Sv.

The same is true for the probes, which means $H^*(10)$ probes also need modification of their energy compensation. The question arises, what will happen, if 6150AD and probe are designed for different measuring quantities. This is no real problem, because each device will measure its quantity. When measuring with an external probe, the probe's technical data including measuring quantity apply. A probe designed for H_x will always provide H_x measurements, even if the indicating 6150AD is already designed for $H^*(10)$. The other way round, a probe designed for $H^*(10)$ will always provide $H^*(10)$ measurements, even if the indicating 6150AD is still designed for H_x . Therefore it is possible to work with a »mixture« of dose rate meters 6150AD and probes that are not designed for the same measuring quantity. However, you have to be careful to add the measuring quantity when documenting your readings.

An alternative would be to design the $H^*(10)$ models of 6150AD and probes in such a way that they will not work together with the old H_x models. The advantage of this approach is that you have to take less care of the measuring quantity when working with an external probe; 6150AD H_x models will only work with H_x probes, and 6150AD $H^*(10)$ models will only work with $H^*(10)$ probes. However, there is also a disadvantage: if you already have several 6150AD and probe models for H_x , and you want to upgrade them to $H^*(10)$ models, you have to do that for all instruments at the same time, because otherwise the probes would not work together with the 6150ADs.

We decided to offer both possibilities. This means that two $H^*(10)$ versions are available for each 6150AD model and for each probe model. Those $H^*(10)$ versions that will also work with old H_x models get the suffix »/H« to their old type name, those $H^*(10)$ versions that will only work with new $H^*(10)$ models get the suffix »/E« to their old type name.

When upgrading a 6150AD to a »/H« model, energy compensation and type label have to be replaced. This is possible even for the oldest instruments. The program version (EPROM) has only to be modified if the instrument's unit was other than Sv, or if the instrument allowed adjusting the unit to something other than Sv. When upgrading to a »/E« model, the program version (EPROM) has always to be modified. This is only possible from hardware release 2 on. In other words, upgrading to a »/E« model is *not* possible for instruments with hardware release 1. The serial number tells you which hardware release an instrument carries, see the table at the bottom of the next page.

Both »/H« and »/E« models clearly indicate the measuring quantity $H^*(10)$ on their type label. If there is no such indication, and if the suffixes »/H« and »/E« are missing, the instrument is an old one designed for H_x .

The table below summarizes the various 6150AD models.

6150AD Models

	range up to	measuring quantity (unit)	additional functions	recognizes probe 6150AD-b	software version		
					EPROM	Flash	
6150AD1	1 Sv/h	H_x or J_s (Sv or R)	no	no	2.02	2.04	
6150AD3			yes	no	35.00	35.01	
6150AD5			yes	yes, 6150AD-b (/H)	41.00	41.01	
6150AD1/H		$H^*(10)$ (Sv)		no	no	2.02	2.04
6150AD3/H				yes	no	57.00	57.02
6150AD5/H				yes	yes, 6150AD-b (/H)	52.00	52.02
6150AD1/E				no	no	2.03	2.05
6150AD3/E				yes	no	57.01	57.03
6150AD5/E				yes	6150AD-b/E only	52.01	52.03
6150AD2	10 mSv/h	H_x or J_s (Sv or R)	no	no	2.02	2.04	
6150AD4			yes	no	35.00	35.01	
6150AD6			yes	yes, 6150AD-b (/H)	41.00	41.01	
6150AD2/H		$H^*(10)$ (Sv)		no	no	2.02	2.04
6150AD4/H				yes	no	57.00	57.02
6150AD6/H				yes	yes, 6150AD-b (/H)	52.00	52.02
6150AD2/E				no	no	2.03	2.05
6150AD4/E				yes	no	57.01	57.03
6150AD6/E				yes	6150AD-b/E only	52.01	52.03

Also, the electronics (hardware) had to develop in time due to changes and progress in technology. Hardware release 2 became necessary because of the increased functionality of models 6150AD3 and 6150AD4. When hardware release 2 could no longer be manufactured because some of the electronic components were no longer available, it had to be replaced by hardware release 3. Until now there is a total of three hardware releases that are summarized in the table below:

hardware release	construction years	models	serial numbers	remarks
1	from 1986 to 1989	6150AD1 (/H) and 6150AD2 (/H) only	6150AD1: up to 64 039 6150AD2: up to 65 601	logic ICs as SMDs (surface mounted devices), other parts as »through hole« types; microprocessor with EPROM 27C32 (24 pins, 4 kbytes).
2	from 1990 to 2003	all models	up to 114 924	mostly SMDs; microprocessor with EPROM 27C64 ... 27C512 (28 pins, 8 kbytes ... 64 kbytes).
3	since 2004	all models	from 114 925 on	all parts SMDs except transformers and calibration switches; microprocessor with flash memory (60 kbytes).

Models for H_x and J_s (all models without »/H« or »/E« suffix) are also available as »Gray« versions. They are not included in the table on the previous page for space reasons. Note that Gray versions use the same calibration factor, which means they assume that 1 Gy = 100 R.

Probes are divided into two categories: the first category, henceforth called »Sv-probes«, comprises all probes indicating dose rate units (Sv/h, R/h, Gy/h). The second category, henceforth called »pulse probes«, comprises all probes indicating pulse rate (S^{-1}).

The 6150AD recognizes the following Sv-probes, which are also available as »/H« and »/E« versions just like the 6150AD itself:

- Gamma Probe 6150AD-15 (/H, /E),
- Gamma Probe 6150AD-18 (/H, /E),
- Telescopic Probe 6150AD-t (/H, /E),
- Scintillator Probe 6150AD-b (/H, /E) (only with 6150AD5/6 as a meter).

The 6150AD recognizes the following pulse probes:

- Alpha-Beta-Gamma Probe 6150AD-17,
- Liquid Probe 6150AD-19,
- general pulse rate probe 6150AD-0 (for example 6150AD-k, Cerberus 763).

Pulse probes serve to detect contamination or activity, not to measure dose rate. Therefore they are not affected by the measuring quantities J_s , H_x , and $H^*(10)$; they do not require »/H« or »/E« versions.

The table below summarizes compatibility between 6150AD meters and probes.

Compatibility with Probes

Probe	Meter		
	6150AD1 - 6150AD6	6150AD1/H - 6150AD6/H	6150AD1/E - 6150AD6/E
Sv-probes for H_x or J_s	yes	yes	error 2
Sv-probes for $H^*(10)$ /H models	yes	yes	error 2
Sv-probes for $H^*(10)$ /E models	error 1	error 1	yes
Pulse probes	yes	yes	yes

All combinations of meter and probe marked »yes« work normally. Errors 1 and 2 display an error message instead of indicating measuring data:

error 1:

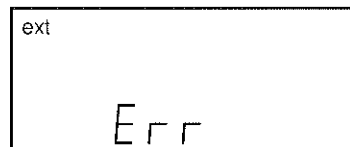

error 2:



xy = 15
18
t
b

The flashing symbols »ext« and »ext xy« point out that the error is related to the external probe. Error 1 tells you that the 6150AD noticed the probe, but that it does not know the probe type (»xy« in »ext xy« left blank). All 6150AD models will indicate this error with unknown probes. Usually unknown probes are such probe types that were developed later than the meter like, for example, the Scintillator Probe 6150AD-b that is unknown to all 6150AD1-4 models. But also hardware errors may lead to this message: if the 6150AD cannot read the probe type because of some electronic fault in the probe, the probe will appear unknown to the meter.

With error 2 the 6150AD tells you that it correctly identified the probe (»xy« in »ext xy« set accordingly), but that it refuses to indicate measuring data because the probe may not be designed for H*(10). Only 6150AD »/E« models will issue this error message to ensure that they will operate with »/E« probes only.

Operation and function do not depend on the measuring quantity. Therefore, from now on we shall mention the »/H« and »/E« suffixes only if they are significant, for example when discussing energy dependence and directional dependence. Unless stated otherwise, all specifications for a model 6150ADx also apply to the corresponding H*(10) models 6150ADx/H and 6150ADx/E.

Likewise, we shall not further discuss the J_s (Roentgen) versions, because this unit is »out of fashion«. All »R« versions have exactly the same ranges as their H_x (Sv) counterparts; they just convert all indications according to the factor 100 R/Sv.

3. Construction

3.1 Housing

The housing is made of waterproof aluminium die casting and has a dark grey scratch-resistant coating. The reverse side carries a short form instruction label and the battery compartment cover, which is fitted with two twist locks. The battery compartment is separated from the electronics compartment by a watertight dividing wall to prevent moisture or other impurities from entering the interior of the instrument when the battery is replaced.

Two eyelets at the bottom corners of the instrument allow fastening the carrying strap.

The housing design meets degree of protection IP 67 according to DIN 40050 (protection against penetration of dust and protection on immersion in water); the instrument is thus easy to decontaminate.

3.2 Location of Detector

The counting tube is located in the centre of the front directly behind the housing wall. A marking spot on the front side indicates this location; it also serves to place a check source. The preferential direction (the direction of radiation incidence with best measuring accuracy) is perpendicular on that marking spot. The triangular arrow symbol on the top side above the LCD also indicates this preferential direction.

preferential direction: perpendicular onto marking spot
on front side

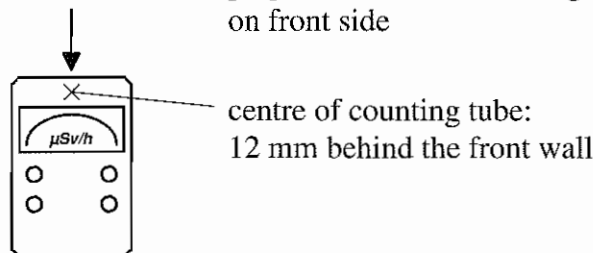

3.3 Display





The display is a static (non-multiplexed) custom designed liquid crystal display (LCD) with an electroluminescence lamp as a backlight.

3.4 Speaker

A piezo buzzer emits audible signals using the housing area among the four keys as a diaphragm, so that no hole is required for a loudspeaker.

3.5 Keys

The top side carries four keys made of silicone rubber, which provide a clear tactile feel, and which can be easily operated even with heavy working gloves. The keys are:

1. On/off key, symbol 
2. Function key (arrow key) to select various functions, symbol 
3. Illumination key, symbol 
4. Signal key for audible signals and selecting alarm thresholds, symbol 

3.6 Probe Socket

A socket on the left-hand side of the instrument serves to connect external probes. The probe connector is equipped with a locking, which has to be observed when plugging or unplugging the connector, see section 5.1.

4. Functions

4.1 Dose Rate Measurement

Dose rate indication is provided in digital and analog form simultaneously. The analog scale covers two decades and consists of 32 bar graph segments arranged in the shape of an arc. Two adjacent ranges always overlap by one decade. To make operation as easy as possible, the 6150AD automatically switches ranges including the analog scale, the decimal point, and the unit. A short sound calls the user's attention every time the range was switched.

The main display is the digital display. The analog display serves merely to indicate trends because the 32 bars over two decades do not allow very accurate readings.

The 6150AD calculates and displays dose rate at one-second intervals. The one-second cycle was chosen for ergonomic reasons. Faster changes of the display, particularly of the digital display, would be difficult to read and would strain the user's eye. You have to consider the one-second cycle when trying to look for changes in dose rate. The instrument will not notice a radiation source if you move it rapidly past that source. You have to concede the instrument at least several cycles, that is several seconds, to notice the source. The time required to indicate the new dose rate value depends on the amount of change in dose rate referred to its initial value. The microprocessor will assist you by adjusting response time in the best way according to the rules of statistics. Section 10 contains more information on response time.

4.2 Audible Single Pulse Detection

Audible single pulse detection enables you to »hear« the pulses. This can be particularly helpful to detect changes in dose rate. Therefore audible single pulse detection is enabled after switching the instrument on. It may be disabled by pressing the signal key. If the loudspeaker symbol in the upper right corner of the LCD is visible, audible single pulse detection is enabled.

Note that the piezo buzzer cannot emit more than approx. 15 clicks per second, whereas at high dose rates much more than 15 pulses per second occur. This means that the frequency of the clicks only reflects a small lower portion of the dose rate range. Therefore, do not try to estimate dose rate from the click frequency; the clicks just provide an acoustic aid at low dose rates.

4.3 Dose Rate Alarm

As soon as dose rate reaches or exceeds the dose rate alarm threshold, the instrument issues dose rate alarm in both audible and visible form. The alarm tone is an intermittent one (two sounds per second), and the flashing loudspeaker symbol in the LCD takes the visual part (with /E models, the analog scale divisions additionally flash to make the alarm even more visible). Pressing the signal key will put the alarm tone out, whereas the symbols will continue to flash. As soon as dose rate drops below the threshold, audible and visible warnings disappear automatically.

The 6150AD will issue dose rate alarm only in the »dose rate indication« state. You have to set the 6150AD1/2 to that state to realize a dose rate alarm. The 6150AD3/4/5/6, however, automatically switches to the »dose rate indication« state as soon as a new dose rate alarm occurs. Therefore the 6150AD3/4/5/6 prevents a dose rate alarm from being overlooked, even if at the time of its occurrence the instrument was in some other state.

All 6150AD models have several fixed dose rate alarm thresholds one of which the user can select. The 6150AD3/4/5/6 additionally provides a user programmable threshold, see section 12.1.

The dose alarm (only provided by 6150AD3/4/5/6) takes precedence over the dose rate alarm in case both alarms should occur simultaneously.

4.4 Dose Rate Mean Value

The 6150AD permanently measures dose rate mean value, which can be displayed with the help of the function key. The dose rate mean value is particularly useful at low dose rates, where direct dose rate indication is subject to strong statistical fluctuations. The mean value provides, though at the expense of measuring time, a statistical accuracy otherwise only achievable with much more sensitive and thus more expensive instruments.

When reading the dose rate mean value two things must be observed:

- The mean value is only reasonable if conditions were stable during its measurement. For example, if a radiation field is to be measured more accurately with the help of the mean value, this radiation field has to be constant in time, and the instrument has to remain at the same place during that measurement. If these conditions are not met, the mean value will only represent a not very meaningful average in time and space.
- You must not overestimate the absolute accuracy of the mean value. It is true that by measuring long enough you can bring down the statistical error to almost any small value, but this does not eliminate other possible error sources such as calibration error, ambient temperature, energy and direction of radiation, instrumental background, and so on. For example, if you leave a 6150AD2/4/6 to itself for 24 hours at natural background of approx. 70 nSv/h, the statistical error of the dose rate mean value will be as low as 1 nSv/h. However, this does not mean you have measured natural background with that accuracy. One uncertainty is, for example, the instrumental background. Although mostly compensated, the instrumental background slightly varies from one instrument to the other; the background remaining after compensation may amount up to approx. 10 nSv/h.

The main purpose of the dose rate mean value is to reduce the statistical error at constant measuring conditions. A typical example is checking the instrument with a check source. This requires an accurate reading and then comparing that reading with some reference value obtained earlier. What then matters is the comparison of two values, not so much their absolute value. The dose rate mean value is best suited for that purpose. Another example is measuring contamination with an external probe. Reading the mean value without and with the object to be checked will allow to detect small increases in pulse rate (for example from 0.1 to 0.3 pulses per second), which would be impossible or at least very inaccurate when reading the pulse rate directly.

As measuring time increases, the mean value becomes increasingly accurate. As a rough indication for accuracy, the digital display flashes until the statistical error has gone down to 5% (to be more precise: until a relative standard deviation of 5% has been achieved). The various models use slightly different methods to check for that 5% error limit. The 6150AD1/2/3/4 assumes the error not to exceed 5% as soon as calculation of the mean value is based on at least 400 pulses. This is correct for statistically distributed pulses originating from counting tubes. The 6150AD5/6, however, also has to process the pulses coming from the Scintillator Probe 6150AD-b, which are not statistically distributed. Therefore, the 6150AD5/6 uses fluctuations of dose rate instead of total pulse count to calculate the standard deviation of the mean value. Now, if conditions change, that is if dose rate changes, the standard deviation calculated from dose rate fluctuations will suddenly start to increase, after it had been decreasing continuously. Consequently, with the 6150AD5/6 you may notice the mean value to start flashing again after it had already been static. Such behaviour indicates changing conditions. The 6150AD1/2/3/4 will not recognize such changing conditions, because it only observes total pulse count. However, under constant conditions, both methods are equivalent, and only constant conditions will give meaningful readings anyway. Therefore, the

6150AD5/6 just has the additional function that it will indicate changing conditions by an increase of standard deviation.

Note that the time required until the 5% error limit has been achieved, and thus the flashing stops, depends on dose rate and the sensitivity of the detector currently in use. It may range from a few seconds to many hours.

Calculating the mean value starts when the instrument is switched on and is not limited in time. It starts again when a probe is connected or disconnected. The 6150AD3/4/5/6 additionally allows to clear the mean value and thus to start its calculation again. Moreover, the 6150AD5/6 is also able to indicate the standard deviation of the mean value.

We shall shortly explain the meaning of the relative standard deviation for users who are not very familiar with this subject. Assume you have measured some value (say, 100) with some relative standard deviation (say, 3%). This does not mean that the »true« value (the value you would have obtained when measuring infinitely) will certainly be within the range $100 \pm 3\%$, that is within the range 97 to 103. It only means that the true value will be within that range with a certain probability. Theory of statistics says:

within one standard deviation are:	68.27%,
within two standard deviations are:	95.45%,
within three standard deviations are:	99.73% of all values.

Applied to the $100 \pm 3\%$ example this means that the true value is within the range of 97 to 103 with a probability of approx. 68%. In other words, there is a probability of $(100-68)\% = 32\%$ that the true value is outside that range. Taking three standard deviations ($3 \cdot 3\% = 9\%$) instead of one results in a range of $100 \pm 9\%$, that is 91 to 109. The probability that the true value is within that range is as high as 99.7%; the probability that the true value is outside that range is as small as $(100-99.7)\% = 0.3\%$. It depends on the application how accurate a value is required. Common practice is to specify two standard deviations as measuring accuracy. This is sometimes called a »two sigma confidence level« or »95% confidence interval«, saying that the true value is with a probability (confidence) of 95% within the specified error interval of $\pm 2\sigma$ (the theory of statistics uses the Greek letter σ , »sigma«, to denote the standard deviation).

4.5 Dose Rate Maximum Value

The 6150AD remembers the dose rate maximum value, which can be displayed with the help of the function key. The maximum value can be useful after a job like, for example, measuring the spatial distribution of a radiation field.

Determination of the maximum value starts when the instrument is switched on. It starts again when a probe is connected or disconnected. The 6150AD3/4/5/6 additionally allows to clear the maximum value and thus to start its determination again.

4.6 Dose

The 6150AD permanently accumulates dose, which can be displayed with the help of the function key. With the 6150AD1/2, dose is always zero after the instrument has been switched on, and after a probe is connected or disconnected. The 6150AD3/4/5/6 has a non-volatile dose memory, see next section.

4.7 Non-volatile Dose Memory (6150AD3/4/5/6 only)

The 6150AD3/4/5/6 provides a non-volatile memory for the dose measured with its internal tube (henceforth called »internal dose«), whereas the 6150AD1/2 does not. The non-volatile memory keeps its contents even when not powered, which means it will maintain the internal dose even while the instrument is switched off. Data retention time is at least ten years.

The internal dose is transferred to the non-volatile memory when the instrument is switched off or when a probe is connected.

When starting to use the internal tube, that is after switching the instrument on, or after disconnecting an external probe, the internal dose is read from the non-volatile memory. Henceforth we shall call this dose value »pre-dose«, because it is a dose originating from a previous use. If the pre-dose is non-zero, it will be displayed immediately. By pressing the corresponding key you now have to decide whether you want to clear it or keep it as an initial value for the new job. Once you left this first automatic dose indication (no matter how, by clearing or keeping the pre-dose), clearing the dose will no longer be possible for safety reasons.

All 6150AD models treat the »probe dose« (the dose measured with a probe) in the same way: the probe dose is always zero when connecting the probe, it cannot be cleared during operation, and it will be lost after disconnecting the probe.

Note: As mentioned above, the internal dose is transferred to non-volatile memory when you switch the instrument off. If you do not switch the instrument off, but just remove the battery during operation, the current internal dose will be lost. The memory will still contain the dose prior to the last use. This fact may be useful in the following case: Assume that after a use the internal dose seems unreasonably high (and the instrument has not yet been switched off), and you suspect this high value to originate from a high pre-dose. To find out the pre-dose, do not switch off but remove the battery, insert the battery again, and switch the instrument on. It will now indicate the pre-dose.

For applications where the non-volatile dose feature is not required, the need to clear the pre-dose every time you switch the instrument on may be annoying. In this case the 6150AD3/4/5/6 may be programmed in such a way that pre-dose will always be zero, just as with the 6150AD1/2 (see section 12.4).

4.8 Dose Alarm (6150AD3/4/5/6 only)

The 6150AD3/4/5/6 provides dose warning, which the 6150AD1/2 does not. As soon as dose reaches the dose alarm threshold, the instrument automatically switches to the »dose indication« state and issues dose alarm in both audible and visible form. The alarm tone is an intermittent one (four sounds per second, twice as fast as with dose rate alarm), and the flashing loudspeaker symbol and the flashing bar graph take the visual part. The only way to acknowledge the dose alarm is to leave the »dose indication« state. You can do so using the function key, or by pressing the signal key, where the latter will automatically return to the ground state »dose rate indication«.

Apart from several fixed dose alarm thresholds the 6150AD3/4/5/6 also provides a user programmable threshold, see section 12.2.

As soon as dose increased by a certain amount, the instrument will repeat dose warning. We shall call this repeated alarm a »post-alarm«. The dose increment required for a post-alarm shall be called »post-alarm increment«; it is a certain percentage of the dose alarm threshold. A post-alarm appears exactly like the first alarm. Every time the dose increased by one post-alarm increment, the instrument issues a new post-alarm, thereby repeatedly reminding the user that the dose exceeds the threshold. The concept of the post-alarm is explained in more detail in the following numerical example:

Dose alarm threshold:	250 μ Sv
Post-alarm increment:	2% (2% of 250 μ Sv = 5 μ Sv)
Dose alarm at:	250 / 255 / 260 / 265 / ... μ Sv

In the above example, the first dose alarm occurs when dose is equal to or greater than 250 μ Sv. Post-alarms will occur every time dose catches up with the next value in the sequence of post-alarm thresholds. This sequence is only limited by the dose range of the detector in use.

You can set the post-alarm increment to one of these values (see section 12.3):

2% / 5% / 10% / no post-alarm

where 2% is factory setting. The post-alarm increment applies to the internal tube and to all probes. If set to »no post-alarm«, only one dose warning will occur when the dose reaches the alarm threshold.

The post-alarm increment will be rounded off to full micro-Sieverts if necessary. For example, 10% of 94 μ Sv will be rounded off to 9 μ Sv, and 10% of 95 μ Sv will be rounded off to 10 μ Sv. Although such »odd« thresholds are unlikely to occur, they cannot be excluded because of the programmable threshold. Also, the post-alarm increment can never be lower than 1 μ Sv or greater than 50 mSv. With thresholds lower than 15 μ Sv, the minimum value of 1 μ Sv causes that each further μ Sv will trigger a post-alarm regardless whether the post-alarm increment is set to 2% / 5% / 10%.

Should dose alarm and dose rate alarm occur simultaneously, dose alarm and dose post-alarm take precedence over the dose rate alarm. You will not notice the dose rate alarm until you acknowledge the dose alarm by leaving dose indication.

When using the instrument with a low dose alarm threshold in a strong radiation field, post-alarms may repeat so frequently that it is impossible to move the instrument to some state other than dose indication. Of course, the first choice remedy would be to leave that radiation field. But there is another possibility: acknowledge the post-alarm by keeping the signal key depressed. As long as you keep the signal key depressed, you will be able to move to the other states using the function key as usual.

You can also use dose thresholds with pulse probes. Everything just mentioned also applies to this category of probes, if you replace »dose« with »pulse count« and »1 μ Sv« with »1 pulse«. For example, you could use a pulse count threshold if you would like to perform a measurement until a certain pulse count corresponding to a certain accuracy is obtained; the warning would then signal the end of the measurement.

4.9 Checking the Battery

A 9 volt battery serves as power supply. The instrument measures battery voltage when it is switched on and from then on at five-minute intervals. You may look at the battery voltage at any time with the help of the function key. When battery life is coming to an end, the instrument issues battery warning in both audible and visible form. After the first occurrence of the battery warning still approx. 70 operating hours will remain (with an alkaline battery, without illumination).

Due to low power consumption, an alkaline battery will last for approx. 1000 operating hours (approx. 3000 hours with instruments equipped with hardware release 3). With the illumination on, battery life considerably drops to approx. 60 hours. Although alkaline batteries are recommended, zinc carbon batteries will also do. You may also use accumulators (rechargeable batteries). However, the voltage of accumulators gives only poor information about their capacity, therefore battery warning will be much less reliable.

4.10 Calibration

The microprocessor calculates dose rate from the tube's pulses in a purely digital way. Calibration parameters are not stored as analog quantities like settings of variable resistors, but as digital numbers, making them totally insensitive to drifts in time. These features ensure high measuring accuracy, also in the long term. Calibration is done at two dose rates, therefore the instrument has two calibration parameters. One parameter compensates the spread of sensitivity of the tubes, the other compensates dead time loss. The calibration parameters may be viewed for service purposes, but modifying them is only possible by adjusting two switches after opening the instrument.

4.11 Operation with Probes

Connecting a probe automatically turns off the internal counting tube and puts the probe's detector in operation. The 6150AD automatically identifies the probe type and displays it in the upper left corner of the LCD. It automatically selects ranges and units for that probe type, including the unit pulses per second for the pulse probes. Just like with the pulses from the internal tube, the pulses originating from the probe are processed in a purely digital way. The microprocessor reads the probe's digital calibration parameters through the probe cable. Therefore you do not have to assign a certain probe to a certain 6150AD. You may operate any probe with any 6150AD without having to fear that the probe's indication might depend on the 6150AD used as a meter.

There are some intentional restrictions as to which probe models work with which 6150AD models, see the table »Compatibility with Probes« at the end of section 2.

5. Operation

Note that each of the keys requires to be pressed for at least 0.25 seconds. A hasty tap on a key may be too short to be recognized. The reason is that the 6150D samples the keys only four times per second; during the time in between it goes into a power saving mode to save batteries.

Pressing a key that will execute some function is acknowledged by a short sound. The illumination key is an exception; here the illumination signals that the instrument has recognized the key.

5.1 Probe Connector Locking

You have to pay attention to the locking of the probe connector when connecting or disconnecting probes. This locking prevents the connector from slipping out of the socket. Plug the connector into the socket until it clicks into place. When unplugging the connector, always seize the connector at the area with the grooves to release the locking.

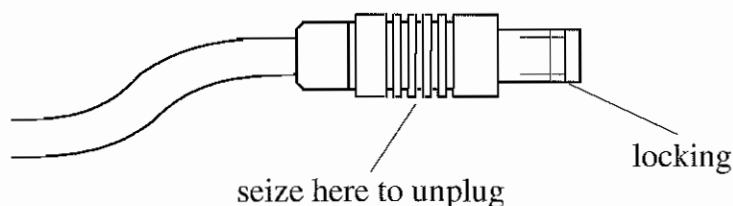

NOTE! Never try to unplug the connector by seizing it at its smooth end or even at the cable! This would not release the locking and thus damage the probe cable!

5.2 Replacing the Battery

To open the battery compartment, the twist locks on the battery compartment cover must be pressed in as far as possible and then twisted approx. 45° counter-clockwise. To close the compartment, align the twist locks according to their grooves and those on the cover, slightly press down the cover, press down the twist locks and turn them clockwise as far as possible, and finally release them. The interlocking pin of the twist lock then snaps into place.

The shape of the battery contacts prevents the battery from being inserted with the polarity reversed. Moreover, the instrument has an electronic reverse polarity protection; applying a reversed polarity will not damage the instrument.

You should remove the battery when not using the instrument for a prolonged period of time.

5.3 Automatic Battery Warning

As soon as battery voltage drops below 5.5 volt, battery life is coming to an end, and the instrument issues battery warning in both audible and visible form. A continuous warning tone accompanies the battery symbol flashing in the upper right corner of the LCD. Pressing the signal key will put the warning tone out, and the battery symbol will then be permanently on. Automatic battery warning is active independent of the state the 6150AD is currently in.

5.4 Switching On and Off, Erase Function of the On/off Key

Pressing the on/off key switches the instrument on¹⁾. As long as you keep the on/off key depressed, all LCD segments are visible and the buzzer is on. This allows checking LCD and buzzer. The LCD test looks like that:

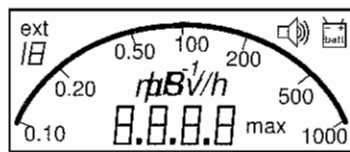

LCD test

After releasing the on/off key the 6150AD displays its software version (firmware version, program version) for two seconds (»/E« models only):

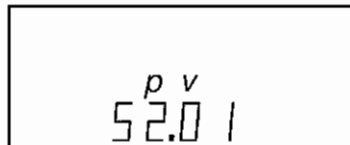

indication of program version (p v)

Only with »/E« models
6150AD1/E to 6150AD6/E

After that the 6150AD displays battery voltage for two seconds to give you automatically an idea about the initial battery condition:

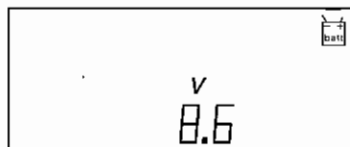

indication of battery voltage in volt units

After that the 6150AD goes to its ground state, that is dose rate indication.

If the pre-dose is non-zero (may occur with 6150AD3/4/5/6 only), then after battery voltage indication the instrument will first indicate the pre-dose to emphasize that there is one. You now have to decide whether you want to clear it or keep it as an initial value for dose accumulation:

- If you want to clear it, press the on/off key twice within three seconds. After the second push the instrument will clear the dose and then automatically turn to dose rate indication.
- If you want to keep it, move the instrument to dose rate indication using the function key (arrow key). Should the pre-dose have triggered dose alarm, you may also move to dose rate indication by pressing the signal key.

It depends on the model how to switch off. The 6150AD1/2 only requires a single push on the on/off key, no matter which state it is currently in. The 6150AD3/4/5/6 has to be in dose rate indication state; while in this state, press the on/off key twice within three seconds. After the second push the instrument will switch off. This shall prevent switching off by mistake or by chance.

In addition to switching on and off, the 6150AD3/4/5/6 uses the on/off key to erase some values. Pressing that key twice within three seconds performs the following functions:

- In state »mean value indication«, the current dose rate mean value will be cleared and the calculation of a new mean value will start. With the 6150AD1/2, the only way to restart the mean value calculation is to switch off and on again, or to connect or disconnect a probe.

¹⁾ In very rare cases it may happen that the microprocessor of hardware release 3 does not start properly when the instrument is switched on. Currently, the reason for this effect is unknown. Strangely enough, this effect only occurs if one tries to switch the instrument on approximately 20 seconds after it was switched off, and even then only once or twice in 100 attempts. This appears like the instrument would not go on at all (the LCD remains blank, although all internal voltages exist). In such a case, you have to remove the battery and wait for at least two full minutes so that the internal voltages can decrease to sufficiently low values. After that you may insert the battery again, and now there will be no problem to switch the instrument on.

- In state »maximum value indication«, the current dose rate maximum value will be cleared and the determination of a new maximum value will start. With the 6150AD1/2, the only way to restart the maximum value determination is to switch off and on again, or to connect or disconnect a probe.
- In state »dose indication«, the dose will be reset to zero and dose accumulation starts again from zero. However, as already mentioned above, resetting of dose is only possible for the internal non-volatile pre-dose that the 6150AD3/4/5/6 displays after it has been switched on or after a probe has been disconnected.

5.5 Illumination Key

Pressing the illumination key switches the LCD backlight on. After releasing that key, illumination will remain on for 10 seconds and then go off. This avoids draining the battery in case you unintentionally switched the illumination on and did not notice it because of bright ambient conditions.

Pressing that key while illumination is already on will extend illumination time, because the 10 seconds of automatic illumination will start again after releasing the key. This also means that you cannot turn illumination off; instead you have to wait until the 10 seconds are over.

5.6 Signal Key (Loudspeaker Key)

The signal key is assigned to alarms and audible signals. It serves to acknowledge alarms and also to select alarm thresholds. Its function depends on the state the 6150AD is currently in. The next section discusses these states including the local function of the signal key.

5.7 Functions called by the Function Key (Arrow Key)

The 6150AD provides the following functions also called the »states« the instrument can be in:

- Indication of dose rate (this is the ground state after the instrument has been switched on, or after a probe has been connected or disconnected),
- Indication of dose rate mean value,
- Indication and selection of dose rate alarm threshold,
- Indication of dose rate maximum value,
- Indication of dose,
- Indication and selection of dose alarm threshold (with 6150AD3/4/5/6 only),
- Indication of battery voltage,
- Indication of calibration parameters (instruments equipped with hardware release 3 additionally allow for indication of the program version by pressing the signal key).

The function key allows to call these states one after the other, where the last state (calibration parameters) returns to the ground state (dose rate). From any state, keeping the function key depressed for three seconds will always return to the ground state.

As already mentioned earlier, the 6150AD3/4/5/6 automatically switches to the corresponding state if an alarm occurs: on dose rate alarm it switches to dose rate indication, and on dose alarm it switches to dose indication. Thereby it forces the user to notice the alarm. Thereafter you may again select some other state if required.

The 6150AD1/2 does not provide dose warning, and on dose rate alarm it will not switch to dose rate indication. You have to put the 6150AD1/2 into the dose rate indication state manually if you want to use dose rate warning.

Pulse probes use s^{-1} as a unit (pulses per second). Everything that was mentioned and that will be mentioned also applies to this category of probes, if you replace »dose rate« with »pulse rate« and »dose« with »pulse count«.

We shall now discuss in detail the particular states, including the action of the on/off key and the signal key within those states.

5.7.1 Indication of Dose Rate

Dose rate indication looks as follows:

internal tube:

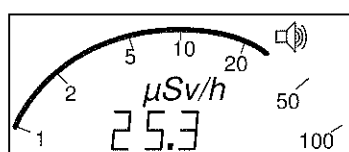

external probe, e.g. 6150AD-17:

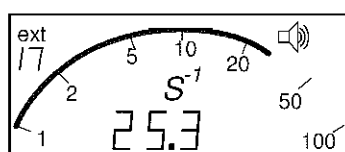

The right-hand example shows how the type of the external probe is indicated as »ext xy« in the upper left corner, and that for pulse probes the unit s^{-1} will be selected. The probe code »xy« below the »ext« symbol may take one of the following values:

- 15 for the Gamma Probe 6150AD-15,
- 18 for the Gamma Probe 6150AD-18,
- 17 for the Alpha-Beta-Gamma Probe 6150AD-17,
- 19 for the Liquid-Sample Probe 6150AD-19,
- t for the Teletector Probe 6150AD-t (low range tube),
- 1t for the Teletector Probe 6150AD-t (high range tube),,
- 0 for any pulse probe with straight pulse rate indication, e.g. 6150AD-k,
- b for the Scintillator Probe 6150AD-b (only with a 6150AD5/6 as a meter).

The digital dose rate indication always comprises three digits. Section 6.1 describes the format in detail.

The loudspeaker symbol in the upper right corner indicates whether audible single pulse detection is enabled. In case of dose rate alarm, the symbol flashes (with /E models, the analog scale divisions additionally flash).

- The signal key clears the dose rate warning tone (the flashing loudspeaker symbol will remain). If the dose rate warning tone is off, the signal key switches audible single pulse detection alternately on and off.
- In the dose rate indication state (and only in this state) you may switch off the 6150AD3/4/5/6 by pressing the on/off key twice within three seconds.

5.7.2 Indication of Dose Rate Mean Value

The dose rate mean value is displayed digitally with four digits:

internal tube:

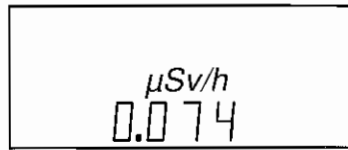

external probe, e.g. 6150AD-17:

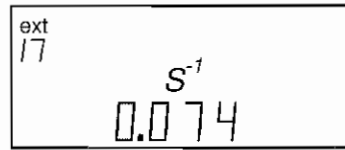

The digits will flash as long as the statistical error (one relative standard deviation) is greater than 5%. The flashing will stop as soon as the 5% limit is achieved. The smaller the dose rate, the longer this will take. For a detailed discussion of the mean value and the standard deviation see section 4.4.

- Connecting or disconnecting a probe clears the current mean value and starts its calculation again. The digits will then start flashing again. Switching the instrument on also starts calculation of the mean value again. The 6150AD3/4/5/6 additionally allows to restart calculation of the mean value by pressing the on/off key twice within three seconds.
- With the 6150AD1/2/3/4, the signal key does not have any function now. With the 6150AD5/6, the signal key alternately switches between indication of mean value and its relative standard deviation. Also when indicating standard deviation, pressing the on/off key twice will restart mean value calculation. Indication of relative standard deviation looks as follows:

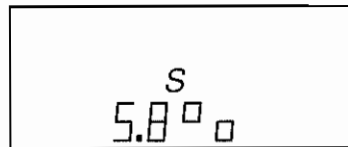

With an external probe you will see the same image just with the probe type »ext xy« added. Indication of relative standard deviation may range from 0.1% to 99%. If the standard deviation is greater than 99%, or if no pulses were counted so far, the instrument will display »99%« flashing. If standard deviation is lower than 0.1%, »0.1% max« will be displayed.

5.7.3 Indication and Selection of Dose Rate Alarm Threshold

The dose rate alarm threshold is displayed digitally with three digits:

internal tube:

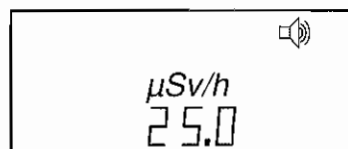

external probe, e.g. 6150AD-17:

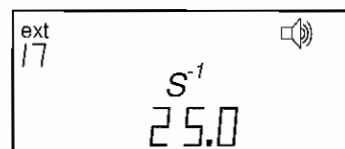

The loudspeaker symbol in the upper right corner shows that this indication concerns a threshold, not a measured value. With the 6150AD1/2 the range starts at 0 μSv/h, with the 6150AD3/4/5/6 at 0.0 μSv/h. The range of the 6150AD3/4/5/6 is extended by one place after the decimal point, so that »odd« values like 7.5 μSv/h may be represented.

If no dose rate alarm threshold is selected (dose rate warning disabled), the digital display of the 6150AD1/2 will be blank, whereas the 6150AD3/4/5/6 will display »OFF«.

- The signal key allows to select a threshold from a set of fixed values, which in case of the 6150AD3/4/5/6 additionally includes the user programmable threshold.

5.7.4 Indication of Dose Rate Maximum Value

The dose rate maximum value is displayed digitally with three digits:

internal tube:

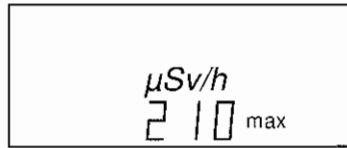

external probe, e.g. 6150AD-17:

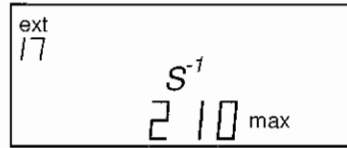

The »max« symbol shows that this indication concerns the maximum value. With the 6150AD1/2 the range starts at 0 $\mu\text{Sv/h}$, with the 6150AD3/4/5/6 at 0.00 $\mu\text{Sv/h}$. That is, the range of the 6150AD3/4/5/6 is extended by two places after the decimal point.

- Connecting or disconnecting a probe clears the current maximum value and starts its determination again. Switching the instrument on also starts determination of the maximum value again. The 6150AD3/4/5/6 additionally allows to restart determination of the maximum value by pressing the on/off key twice within three seconds.
- In this state the signal key has no function.

5.7.5 Indication of Dose

The dose is displayed digitally with three digits. The 6150AD3/4/5/6 additionally displays an analog bar graph representing the dose as a portion of the dose alarm threshold:

internal tube:

6150AD1/2:

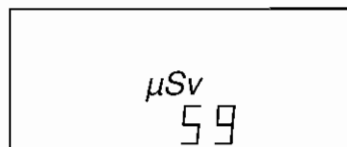

6150AD3/4/5/6:

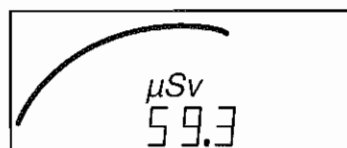

external probe, e.g. 6150AD-17:

6150AD1/2:

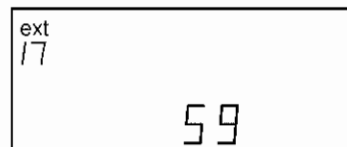

6150AD3/4/5/6:

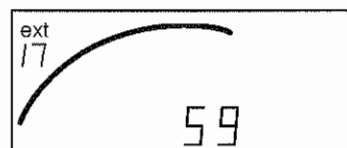

With the 6150AD1/2 the range starts at 0 μSv , with the 6150AD3/4/5/6 at 0.00 μSv . That is, the range of the 6150AD3/4/5/6 is extended by two places after the decimal point. The »dose« of pulse probes, that is the pulse count, is always represented as an integer value.

Note that the bar does not indicate the dose on a Sievert scale (this is why there are no scale divisions along the bar), but as the portion of the dose alarm threshold. For example, if the threshold is 100 μSv , and the dose is 50 μSv , that is half of the threshold, the first 16 of the 32 bar graph segments will be visible. The bar acts as a level gauge, where »full« means dose alarm. Thus the user may easily recognize what portion of the threshold the current dose corresponds to. In case of dose alarm, all of the 32 bar graph segments and the loudspeaker symbol will be flashing, accompanied by the fast dose warning tone with four sounds per second. If dose warning is disabled, the bar graph will be suppressed.

Each increase of the dose by one μSv is accompanied by a short sound.

- With the 6150AD3/4/5/6, you can reset the dose to zero by pressing the on/off key twice within three seconds. However, for safety reasons this is only possible for the internal non-volatile pre-dose that the 6150AD3/4/5/6 displays after it has been switched on or after a probe has been disconnected.
- In case of dose alarm you may acknowledge the dose alarm by pressing the signal key; this will return to the ground state, dose rate indication. If there is no dose alarm, pressing the signal key will have no effect.

5.7.6 Indication and Selection of Dose Alarm Threshold (6150AD3/4/5/6 only)

Only the 6150AD3/4/5/6 provides dose alarm thresholds. The threshold is displayed digitally with three digits:

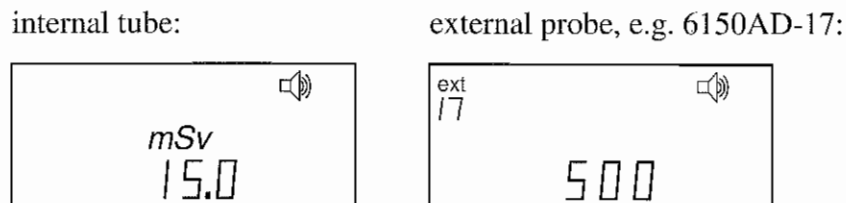

The loudspeaker symbol in the upper right corner shows that this indication concerns a threshold, not a measured value. If no dose alarm threshold is selected (dose warning disabled), the digital display will contain the text »OFF«.

- The signal key allows to select a threshold from a list containing a set of fixed values and the user programmable threshold. Please note that the instrument checks for dose alarm every time the threshold is modified. If you move from a greater threshold to a smaller one, you may trigger dose alarm.

With pulse probes, the threshold is a pulse count threshold. For your convenience, you may use a pulse count threshold to signal the end of a measurement that requires a minimum pulse count. However, this seems quite a special application. Therefore the instrument does not provide standard pulse count thresholds. Such a threshold has to be programmed if required.

5.7.7 Indication of Battery Voltage

The voltage of the 9 volt battery is displayed digitally:

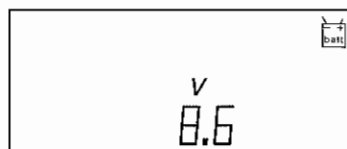

The range goes from 5.5 volt to approx. 10.0 volt. At voltages below 5.5 volt (which is also the limit for battery warning) the digits »5.5« will flash.

With an external probe you will see the same image just with the probe type »ext xy« added. However, this does not mean that the probe's battery is concerned. It always concerns the 6150AD's battery, because probes are supplied from the 6150AD through the probe cable; probes do not have batteries at all.

- In this state the signal key has no function.

5.7.8 Indication of Calibration Parameters

Calibration parameters are indicated for service purposes only. Each of the two parameters represents the setting of an internal hexadecimal switch. Such a switch has 16 positions denoted by the numbers 0 to 9 and the letters A, b, C, d, E, F:

internal tube:

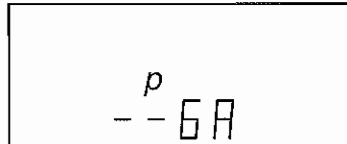

external probe, e.g. 6150AD-t:

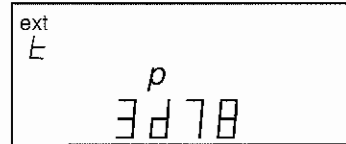

The left-hand example shows an internal tube with parameters »6A«. The right-hand example shows a Teletector Probe 6150AD-t. This probe has two tubes and consequently four parameters. The example shows a high range tube with »3d« as parameters, and a low range tube with »78« as parameters.

- With hardware releases 1 and 2, the signal key has no function in this state. With hardware release 3, the program version will be indicated while the signal key is kept depressed:

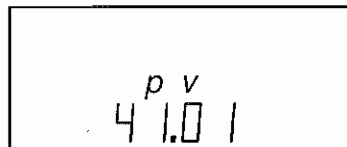

while the signal key is held down
(with hardware release 3 only):

indication of program version (p v)

6. Display Ranges and Display Formats

This section describes all the ranges and their formats in detail.

First we would like to add some comments on pulse probes. We decided to display the unit »pulses per second« as »s⁻¹«, because other representations like »cps«, »Imp/s«, or »c/s« are not in common international use and would take much of the LCD's space. Large pulse rates are represented as »ks⁻¹«, where »k« stands for the prefix »kilo«. 1 ks⁻¹ means 1000 pulses per second. This is not quite correct, because just like cm⁻¹ means »per centimetre«, that is 1/(cm), ks⁻¹ would mean »per kilosecond«, that is 1/(ks). Then 1 ks⁻¹ would mean 1 pulse per 1000 seconds. Strictly speaking one would have to represent 1000 pulses per second as one pulse per millisecond, that is 1 ms⁻¹. However, we thought that this representation would be more difficult to understand, especially for users not very familiar with mathematical notations. Therefore we decided to use ks⁻¹ as a unit for large pulse rates. The risk, that ks⁻¹ will be wrongly read as 1/(ks), is low, because firstly kiloseconds are not a common unit, and secondly the 6150AD represents the letter »s« as a capital letter: »kS⁻¹«. Conclusion: If the 6150AD indicates 1 kS⁻¹, this means 1000 pulses per second.

6.1 Dose Rate

There are eight dose rate ranges that cover two decades each. Two adjacent ranges always overlap by one decade. Although it has a total of four digits, the display contains at most three significant digits (non-zero digits). Those three digits are the lower three ones in the lower decade of a range, and the upper three ones in the upper decade. This allows the decimal point to maintain its position within a range, which makes reading easier.

The levels to switch up to the next range and to switch down to the previous range are not equal, they have a ratio of 10:2 (also known as »hysteresis«). For example, when dose rates exceeds 100 µSv/h, the 6150AD switches to the next range, but will not switch back to the lower range until dose rate drops below 20 µSv/h. If those two levels were equal, and dose rate would be close to that level, the instrument would keep switching between the two ranges, which would make the instrument quite difficult to read.

The 6150AD automatically selects the lowest and the highest range for each detector (internal tube or probe). The table on the next page shows the eight dose rate ranges and their assignment to the individual detectors.

range no.	dose rate ranges:							
	1	2	3	4	5	6	7	8
analog scale start	10	0.1	1	10	0.1	1	10	0.1
analog scale centre	100	1	10	100	1	10	100	1
analog scale end	1000	10	100	1000	10	100	1000	10
unit	nSv/h	µSv/h	µSv/h	µSv/h	mSv/h	mSv/h	mSv/h	Sv/h
digital display format:								
6150AD1/3/5 internal tube			_0.0_ - 99.9_	_20.0_ - _99.9_	0.200 - 0.999	_2.00_ - _9.99_	_20.0_ - _99.9_	
6150AD2/4/6 internal tube, probe 6150AD-18		0.00_ - 9.99_	_2.00_ - _9.99_	_20.0_ - _99.9_	0.200 - 0.999			
probe 6150AD-15					0.00_ - 9.99_	_2.00_ - _9.99_	_20.0_ - _99.9_	0.200 - 0.999
probe 6150AD-t		0.00_ - 9.99_	_2.00_ - _9.99_	_20.0_ - _99.9_	0.200 - 0.999	_2.00_ - _9.99_	_20.0_ - _99.9_	0.200 - 0.999
probe 6150AD-b	_0_ - 999_	0.200 - 0.999	_2.00_ - _9.99_					

When exceeding the highest range, the flashing full scale value (»9...9«) will indicate overrange.

Remark on the Teletector Probe 6150AD-t: ranges no. 2 to 5 are assigned to the low range tube, and ranges no. 6 to 8 are assigned to the high range tube. When switching between these ranges, the 6150AD switches between the two tubes accordingly.

For pulse probes there are six pulse rate ranges that will also be selected automatically:

range no.	pulse rate ranges:					
	1	2	3	4	5	6
analog scale start	0.1	1	10	0.1	1	10
analog scale centre	1	10	100	1	10	100
analog scale end	10	100	1000	10	100	1000
unit	S ⁻¹	S ⁻¹	S ⁻¹	kS ⁻¹	kS ⁻¹	kS ⁻¹
digital display format:						
probes 6150AD-17, 6150AD-19	0.00_ - 9.99_	_2.00 - _9.99 and 10.0_ - 99.9_	_20.0 - _99.9 and 100_ - 999_	0.200 - 0.999 and 1.00_ - 9.99_		
probe 6150AD-0	0.00_ - 9.99_	_2.00 - _9.99 and 10.0_ - 99.9_	_20.0 - _99.9 and 100_ - 999_	0.200 - 0.999 and 1.00_ - 9.99_	_2.00 - _9.99 and 10.0_ - 99.9_	_20.0 - _99.9 and 100_ - 999_

When exceeding the highest range, the flashing full scale value (»9...9«) will indicate overrange.

Remark on the probe 6150AD-0: this is a general purpose probe type, the pulse rate of which is indicated directly without applying any calibration factor. We created this probe type for future developments of pulse probes that will connect to any 6150AD model. Because one cannot foresee the range of a future pulse probe, the 6150AD-0 range goes up to 999 kS⁻¹, that is approx. 1 MHz, which is about the maximum count capacity of the 6150AD. That high range is a reserve for the future not required by any of the probes currently available.

6.2 Dose Rate Mean Value

Ranges and formats are equal for all 6150AD models.

internal tubes and Sv-probes	pulse probes
0.000 - 9.999 µSv/h	0.000 - 9.999 S ⁻¹
10.00 - 99.99 µSv/h	10.00 - 99.99 S ⁻¹
100.0 - 999.9 µSv/h	100.0 - 999.9 S ⁻¹
1.000 - 9.999 mSv/h	1000 - 9999 S ⁻¹

The range is the same for all detectors (internal tubes and probes). However, the Scintillator Probe 6150AD-b cannot use the full range because its dose rate range ends at 99.9 µSv/h. You may observe mean values greater than 99.9 µSv/h with the 6150AD-b, but such mean values are not reliable because they are out of range.

When exceeding the highest range, the flashing full scale value (»9...9«) will indicate overrange.

6.3 Dose Rate Alarm Threshold

Internal tubes and Sv-probes use three digits with floating decimal point and variable unit. With the 6150AD1/2 the smallest step is 1 $\mu\text{Sv/h}$, and with the 6150AD3/4/5/6 the smallest step is 0.1 $\mu\text{Sv/h}$.

With pulse probes, the 6150AD1/2 indicates integer values in S^{-1} , whereas the 6150AD3/4/5/6 uses three digits with floating decimal point and variable unit, where the smallest step is 0.1 S^{-1} .

internal tubes and Sv-probes		pulse probes	
6150AD1/2	6150AD3/4/5/6	6150AD1/2	6150AD3/4/5/6
0 - 999 $\mu\text{Sv/h}$	0.0 - 99.9 $\mu\text{Sv/h}$	0 - 9999 S^{-1}	0.0 - 99.9 S^{-1}
	100 - 999 $\mu\text{Sv/h}$		100 - 999 S^{-1}
	1.00 - 9.99 mSv/h		1.00 - 9.99 kS^{-1}
	10.0 - 99.9 mSv/h		10.0 - 99.9 kS^{-1}
	100 - 999 mSv/h		100 - 999 kS^{-1}
1.00 - 9.99 Sv/h			

The table shows the 6150AD's entire range. The upper limit of the range will automatically be restricted to the dose rate range of the corresponding detector (internal tube or probe).

6.4 Dose Rate Maximum Value

The range of the dose rate maximum value is the same as for the dose rate alarm threshold (see preceding section), except that the range is extended by one place after the decimal point. Thus the smallest steps are 0.01 $\mu\text{Sv/h}$ and 0.01 S^{-1} , respectively.

internal tubes and Sv-probes		pulse probes	
6150AD1/2	6150AD3/4/5/6	6150AD1/2	6150AD3/4/5/6
0 - 999 $\mu\text{Sv/h}$	0.00 - 9.99 $\mu\text{Sv/h}$	0 - 9999 S^{-1}	0.00 - 9.99 S^{-1}
	10.0 - 99.9 $\mu\text{Sv/h}$		10.0 - 99.9 S^{-1}
	100 - 999 $\mu\text{Sv/h}$		100 - 999 S^{-1}
	1.00 - 9.99 mSv/h		1.00 - 9.99 kS^{-1}
	10.0 - 99.9 mSv/h		10.0 - 99.9 kS^{-1}
100 - 999 mSv/h			
1.00 - 9.99 Sv/h			

The table shows the 6150AD's entire range. The upper limit of the range will automatically be restricted to the dose rate range of the corresponding detector (internal tube or probe).

When exceeding the highest range, the flashing full scale value ($\gg 9 \dots 9 \ll$) will indicate overrange.

6.5 Dose

Internal tubes and Sv-probes use three digits with floating decimal point and variable unit. With the 6150AD1/2 the smallest step is 1 μSv , and with the 6150AD3/4/5/6 the smallest step is 0.01 μSv .

With pulse probes, the smallest step is always 1 (one pulse). The 6150AD1/2 indicates integer pulse counts up 9999, whereas the 6150AD3/4/5/6 uses three digits with floating decimal point and variable unit.

internal tubes and Sv-probes		pulse probes	
6150AD1/2	6150AD3/4/5/6	6150AD1/2	6150AD3/4/5/6
0 - 999 μSv	0.00 - 9.99 μSv	0 - 9999	0 - 999
	10.0 - 99.9 μSv		1.00 - 9.99 k
	100 - 999 μSv		10.0 - 99.9 k
	1.00 - 9.99 mSv		100 - 999 k
	10.0 - 99.9 mSv		
	100 - 999 mSv		
	1.00 - 9.99 Sv		

The table shows the 6150AD's entire range. The upper limit of the range will automatically be restricted to the dose range of the corresponding detector (internal tube or probe).

When exceeding the highest range, the flashing full scale value (»9...9«) will indicate overrange.

6.6 Dose Alarm Threshold (6150AD3/4/5/6 only)

This section only applies to the 6150AD3/4/5/6, because the 6150AD1/2 does not provide dose alarm thresholds. The smallest step is always 1 μSv or 1 (one pulse), respectively.

internal tubes and Sv-probes	pulse probes
0 - 999 μSv	0 - 999
1.00 - 9.99 mSv	1.00 - 9.99 k
10.0 - 99.9 mSv	10.0 - 99.9 k
100 - 999 mSv	100 - 999 k
1.00 - 9.99 Sv	

The table shows the 6150AD's entire range. The upper limit of the range will automatically be restricted to the dose range of the corresponding detector (internal tube or probe).

7. Measuring Ranges

You may wonder what the difference between a measuring range and a display range may be. In fact, the answer to that question may depend on national regulations. We shall give you some ideas about German regulations dividing a simple range into a »display range« and a »measuring range«. Note, however, that regulations in your country may be different.

According to German regulations, a measuring range is that portion of the display range meeting certain accuracy requirements. You may regard the measuring range as the »useful« part of the display range. For example, the error of a radiation meter must not exceed 20%. This has a simple consequence for digital ranges. With a digital range, there is always an uncertainty of ± 1 in the least significant digit. If that uncertainty shall not make more than 20%, the measured value must amount to »5« or more in the last digit. For example, if a display range starts at 0.00, the measuring range cannot start below 0.05. As another example, fluctuation (standard deviation) of dose rate indication must not exceed a certain limit. Usually such requirements are more difficult to fulfil at low dose (rate) values than at high ones. Therefore, in most cases the beginning of a measuring range will be above the beginning of the display range, whereas the ends of measuring and display range are usually equal.

7.1 Dose Rate Measuring Ranges

The maximum standard deviation determines the beginning of the dose rate measuring range. The measuring ranges shown in the table below comply with the requirement, that the relative standard deviation must not exceed 5% at dose rates above 20 $\mu\text{Sv/h}$, and must not exceed 15% at dose rates below 20 $\mu\text{Sv/h}$. The end of the dose rate measuring range is equal to the end of the corresponding digital display range.

6150AD1/3/5 internal tube	0.2 mSv/h - 999 mSv/h
6150AD2/4/6 internal tube	2 $\mu\text{Sv/h}$ - 9.99 mSv/h
probe 6150AD-18	2 $\mu\text{Sv/h}$ - 9.99 mSv/h
probe 6150AD-15	1 mSv/h - 9.99 Sv/h
probe 6150AD-t	2 $\mu\text{Sv/h}$ - 9.99 Sv/h
probe 6150AD-b	50 nSv/h - 99.9 $\mu\text{Sv/h}$

The dose rate measuring ranges of the probes are valid regardless of the 6150AD model they are used with.

7.2 Dose Measuring Ranges

Resolution of digital dose indication and a certain minimum pulse count determine the beginning of a dose measuring range. The end of the range corresponds to a 10 hour operation at the maximum dose rate the detector is specified for (except for pulse probes). For example, the end of the dose range of the 6150AD1/3/5 is equal to $999 \text{ mSv/h} \cdot 10 \text{ h} = 9.99 \text{ Sv}$.

	6150AD1/2	6150AD3/4/5/6
6150AD1 internal tube 6150AD3/5 internal tube	5 μSv - 9.99 Sv	0.2 μSv - 9.99 Sv
6150AD2 internal tube 6150AD4/6 internal tube	5 μSv - 99.9 mSv	0.1 μSv - 99.9 mSv
probe 6150AD-18	5 μSv - 99.9 mSv	0.1 μSv - 99.9 mSv
probe 6150AD-15	5 μSv - 9.99 Sv	0.4 μSv - 9.99 Sv
probe 6150AD-t	5 μSv - 9.99 Sv	0.1 μSv - 9.99 Sv
probe 6150AD-b (with 6150AD5/6 only)		0.05 μSv - 999 μSv

As can be seen from the table, the beginning of the dose measuring range of a Sv-probe does not only depend on the probe type itself, but also on the 6150AD model used as a meter.

8. Fixed Alarm Thresholds

This section summarizes numbers and values of the thresholds for dose and dose rate that were preset at the factory. Among those preset values are default thresholds for the internal tube and the probes. After switching on, the default threshold for the internal tube is active. After connecting a probe, the default threshold for that probe type is active. If you select a non-default threshold for the internal tube, the 6150AD will remember that threshold across the intermediate use of a probe, which means that after connecting and disconnecting a probe that threshold will be active again. If you select a non-default threshold for a probe, that threshold will be forgotten after the probe was disconnected, which means that after reconnecting the probe the probe's default threshold will be active again. All this applies to both dose rate alarm threshold and dose alarm threshold.

The 6150AD3/4/5/6 allows to program thresholds for the internal tube and for all probe types to any value within the detector's range. Such a custom-made threshold replaces the »OFF« state and is active after switching the instrument on or after connecting a probe, respectively. This means that the custom-made threshold takes precedence over the preset default value. However, the set of fixed thresholds is still available for selection by means of the signal key. This also applies to both dose rate alarm threshold and dose alarm threshold.

8.1 Dose Rate Alarm Thresholds

internal tube of 6150AD1/3/5	internal tube of 6150AD2/4/6, probe 6150AD-18	probes 6150AD-15, 6150AD-t	probe 6150AD-b (only with 6150AD5/6 as a meter)	pulse probes 6150AD-17, 6150AD-19, 6150AD-0
OFF	OFF	OFF	» OFF	OFF
» 25.0 $\mu\text{Sv/h}$	7.5 $\mu\text{Sv/h}$	250 $\mu\text{Sv/h}$	7.5 $\mu\text{Sv/h}$	7.5 S^{-1}
250 $\mu\text{Sv/h}$	» 25.0 $\mu\text{Sv/h}$	» 1.00 mSv/h	25.0 $\mu\text{Sv/h}$	» 25.0 S^{-1}
1.00 mSv/h	100 $\mu\text{Sv/h}$	2.50 mSv/h		100 S^{-1}
2.50 mSv/h	2.00 mSv/h	10.0 mSv/h		2.00 kS^{-1}
10.0 mSv/h	3.00 mSv/h	25.0 mSv/h		3.00 kS^{-1}

Remarks:

1. With the 6150AD1/2, the threshold 7.5 ($\mu\text{Sv/h}$ or S^{-1}) takes the value 7 ($\mu\text{Sv/h}$ or S^{-1}), because the 6150AD1/2 can only store integer dose rate thresholds. Apart from that, all 6150AD models provide the same sets of thresholds; only the format (number of digits after the decimal point) may vary, see section 6.3.
2. The option »OFF« (warning disabled) appears differently according to the model: when indicating the dose rate alarm threshold, the 6150AD1/2 leaves the digital display blank, whereas the 6150AD3/4/5/6 displays »OFF«.
3. »» « marks the default threshold that is active after switching on or after connecting a probe.

8.2 Dose Alarm Thresholds (6150AD3/4/5/6 only)

Only the 6150AD3/4/5/6 provides dose alarm thresholds.

internal tube of 6150AD3/5, probe 6150AD-15	internal tube of 6150AD4/6, probe 6150AD-18	probes 6150AD-t, 6150AD-b	pulse probes 6150AD-17, 6150AD-19, 6150AD-0
OFF	OFF	» OFF	» OFF
» 15.0 mSv	» 1.00 mSv		
100 mSv	2.00 mSv		
250 mSv			

Remark:

»» « marks the default threshold that is active after switching on or after connecting a probe.

9. Energy Dependence and Directional Dependence

The following radiation sources were used to obtain the data presented in this section:

- Cs-137 (662 keV),
- Co-60 (mean energy 1250 keV),
- filtered X radiation according to the N series (»Narrow spectrum«) from ISO 4037-1.

The diagrams show typical curves, in practice slight deviations are normal and cannot be avoided.

All energy curves are normalized to the indication at Cs-137. Directional dependencies of H_x models are normalized to the indication in preferential direction at the same energy. Directional dependencies of $H^*(10)$ models are normalized to the indication in preferential direction at Cs-137. The reason for the different normalization of directional dependencies is that the change from H_x to $H^*(10)$ was accompanied by a change of official requirements:

- For H_x models, the energy dependence in preferential direction was required not to deviate by more than $\pm 30\%$ referred to Cs-137. The directional dependence within a cone of $\pm 45^\circ$ around the preferential direction was required not to deviate by more than $\pm 20\%$ referred to the same energy in preferential direction. This means that requirements for energy dependence and directional dependence were completely independent of each other. There was no consideration for the fact that errors may compensate or add. For example, if an instrument had an error of -30% at some energy, and at that energy additionally an error of -20% at some direction, it meets the requirements, although the errors add to a total error of -44% ($0.7 \cdot 0.8 = 0.56 = 1.00 - 44\%$). On the other hand, an instrument with an energy error of -30% and a directional error of $+40\%$ does not meet the requirements, although both errors almost compensate leaving an error of only -2% ($0.7 \cdot 1.4 = 0.98 = 1.00 - 2\%$).
- For $H^*(10)$ models, there is no separate but a combined requirement for energy and directional dependence. It says that, for all energies and all directions within a cone of $\pm 45^\circ$ around the preferential direction, the error must not exceed $\pm 40\%$ referred to indication at Cs-137 in preferential direction. The new requirement has little to do with the new quantity $H^*(10)$ itself; it was introduced together with $H^*(10)$ merely because it was regarded to be more realistic.

The range meeting the requirements is called »nominal energy range«. When using the instrument you have to observe that energy is within that range. In other words, you need to know something about the radiation to be measured:

- If radiation energy is considerably lower than the beginning of the nominal energy range, the instrument's response will decrease considerably even down to »blindness«. You will then underestimate the radiation field. This may particularly happen with low energy X radiation.
- It depends on the type of instrument how it responds to energies above the end of the nominal energy range. A common question is how an instrument will respond to the 6 MeV radiation of N-16 that occurs in a nuclear facility. It is well-known that energy compensated GM tubes as used in the 6150AD will always overrespond at such high energies (up to three times the true value). Therefore, although the 6150AD is not suited to measure such a high energy radiation field correctly, it will overestimate the radiation and thus the radiation risk. In terms of radiation protection, it will be more strict than it has to be.

9.1 6150AD1, 6150AD3, 6150AD5

Energy dependence referred to photon dose equivalent H_x :

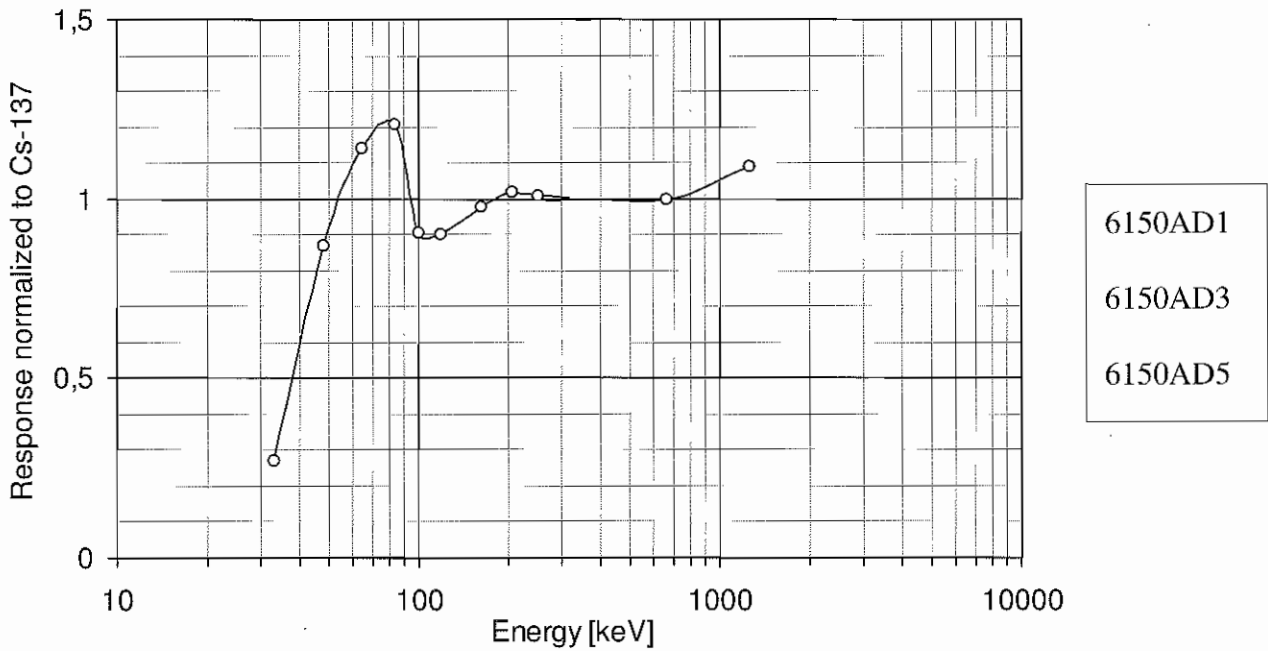

Directional dependence (horizontal rotation) normalized to the same energy in preferential direction. The error shall not exceed $\pm 20\%$ down to energies 20 keV above the beginning of the nominal energy range:

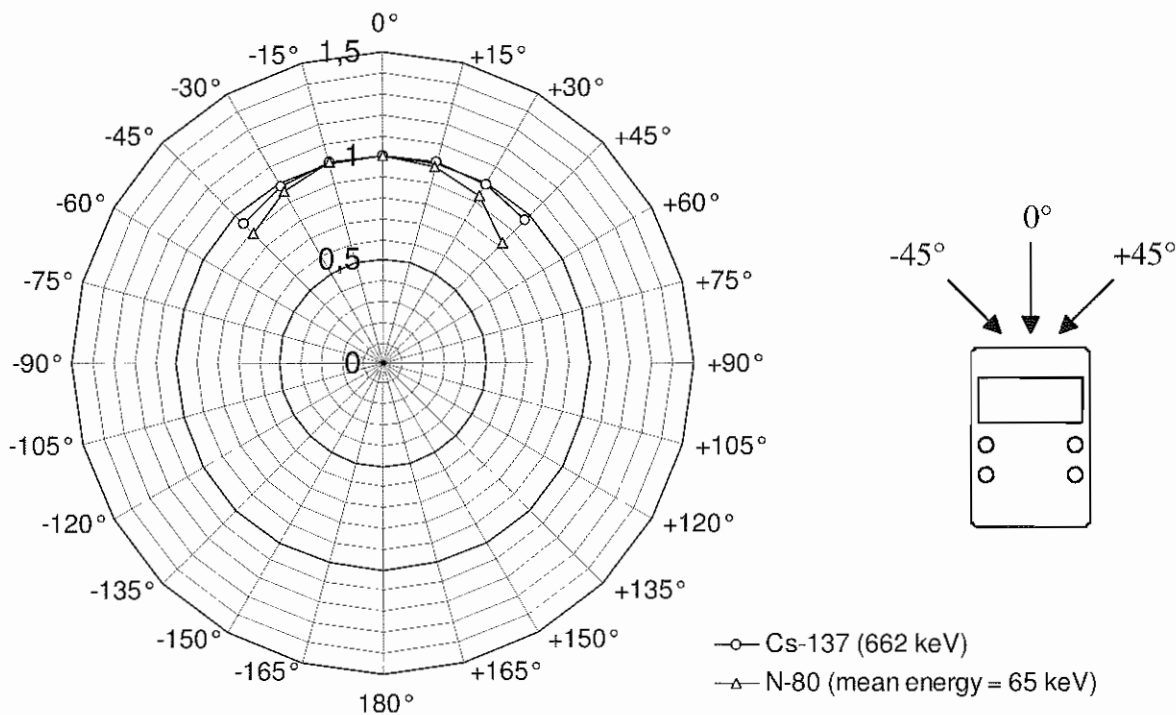

Vertical rotation (rotation around the tube's axis) within an angular range of $\pm 45^\circ$ will change response only by a few percent making a graphical representation unnecessary.

9.2 6150AD1, 6150AD3, 6150AD5 (/H and /E models)

Energy dependence referred to ambient dose equivalent $H^*(10)$:

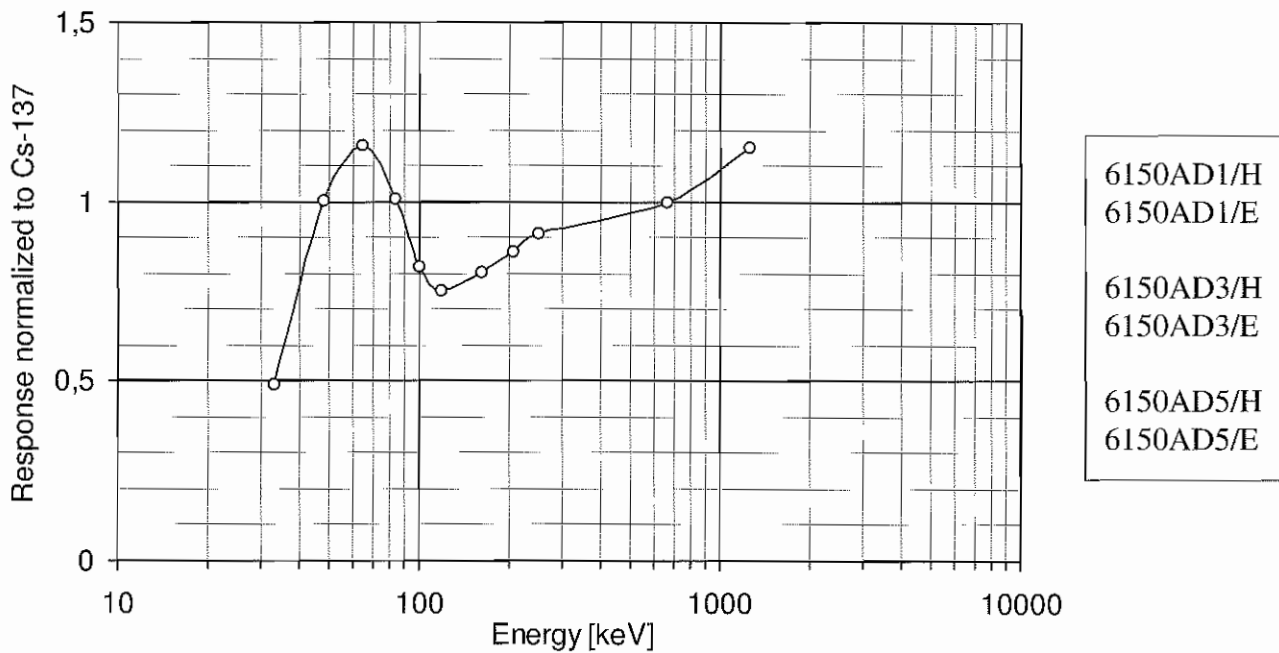

Directional dependence (horizontal rotation) normalized to Cs-137 in preferential direction. The error shall not exceed $\pm 40\%$ for all energies and directions within their nominal ranges:

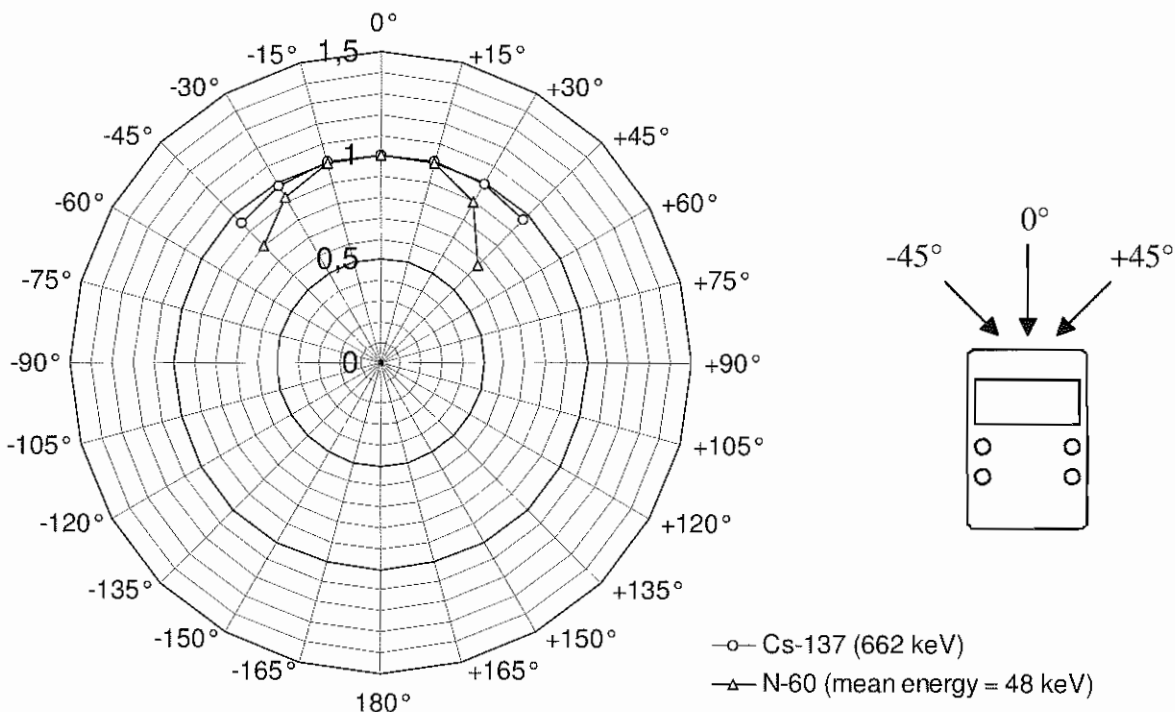

Vertical rotation (rotation around the tube's axis) within an angular range of $\pm 45^\circ$ will change response only by a few percent making a graphical representation unnecessary.

9.3 6150AD2, 6150AD4, 6150AD6

Energy dependence referred to photon dose equivalent H_x :

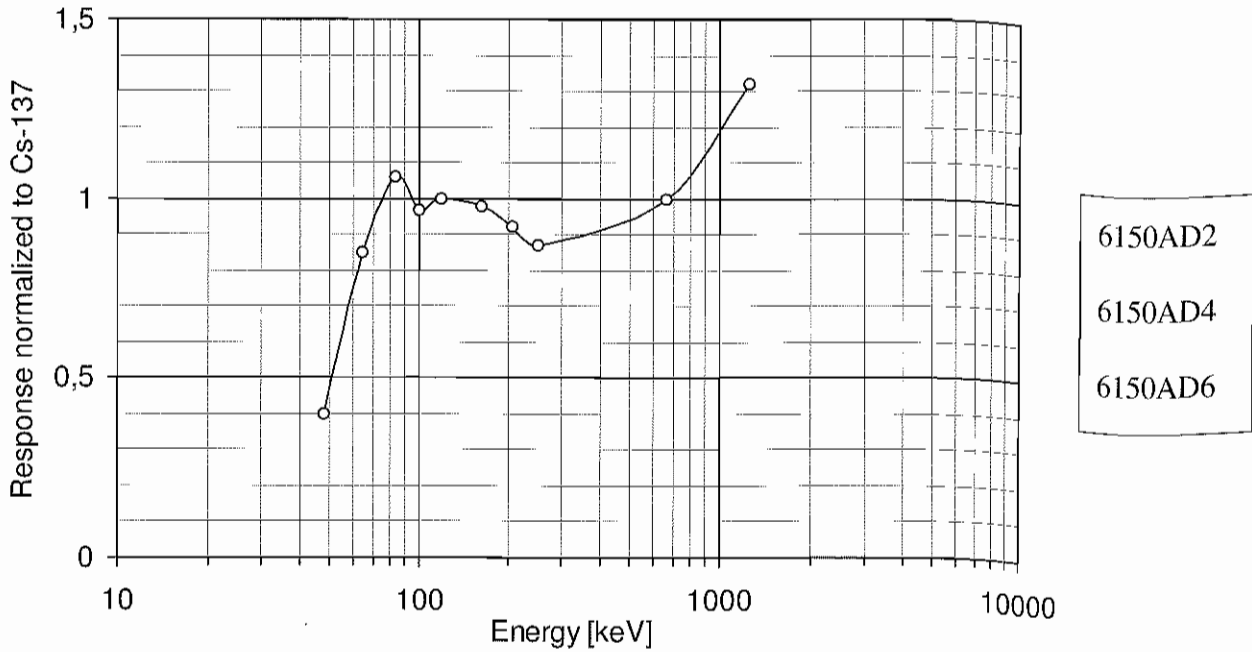

Directional dependence (horizontal rotation) normalized to the same energy in preferential direction. The error shall not exceed $\pm 20\%$ down to energies 20 keV above the beginning of the nominal energy range:

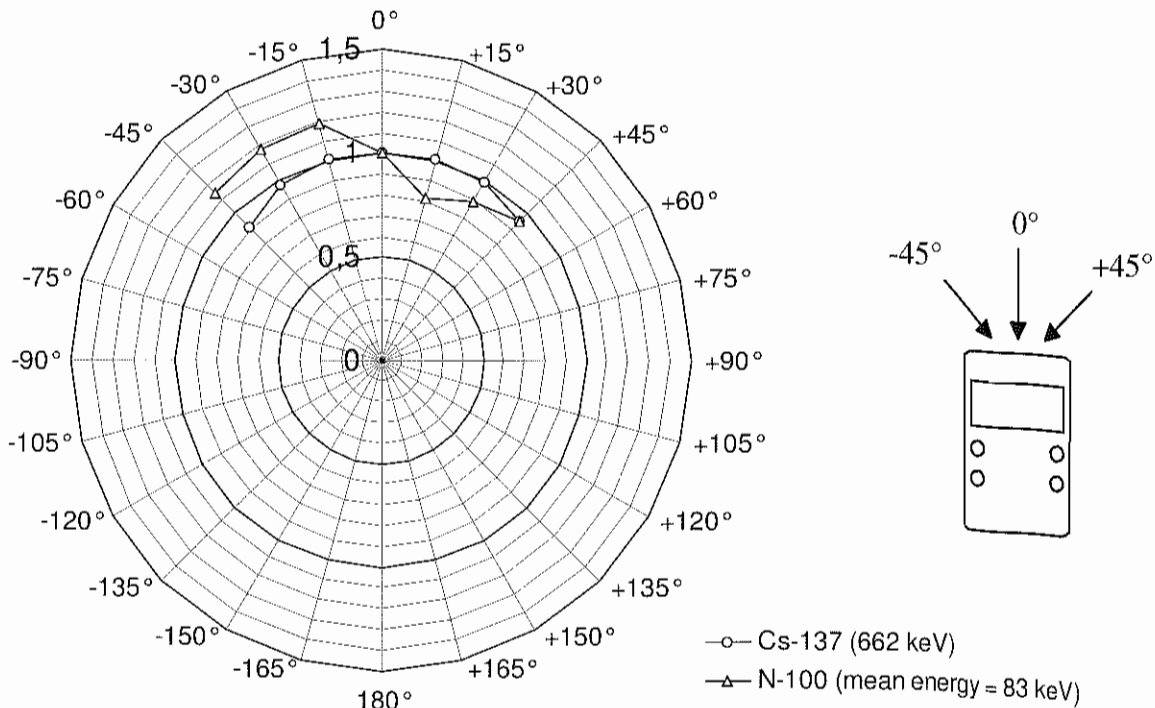

Vertical rotation (rotation around the tube's axis) within an angular range of $\pm 45^\circ$ will change response only by a few percent making a graphical representation unnecessary.

9.4 6150AD2, 6150AD4, 6150AD6 (/H and /E models)

Energy dependence referred to ambient dose equivalent $H^*(10)$:

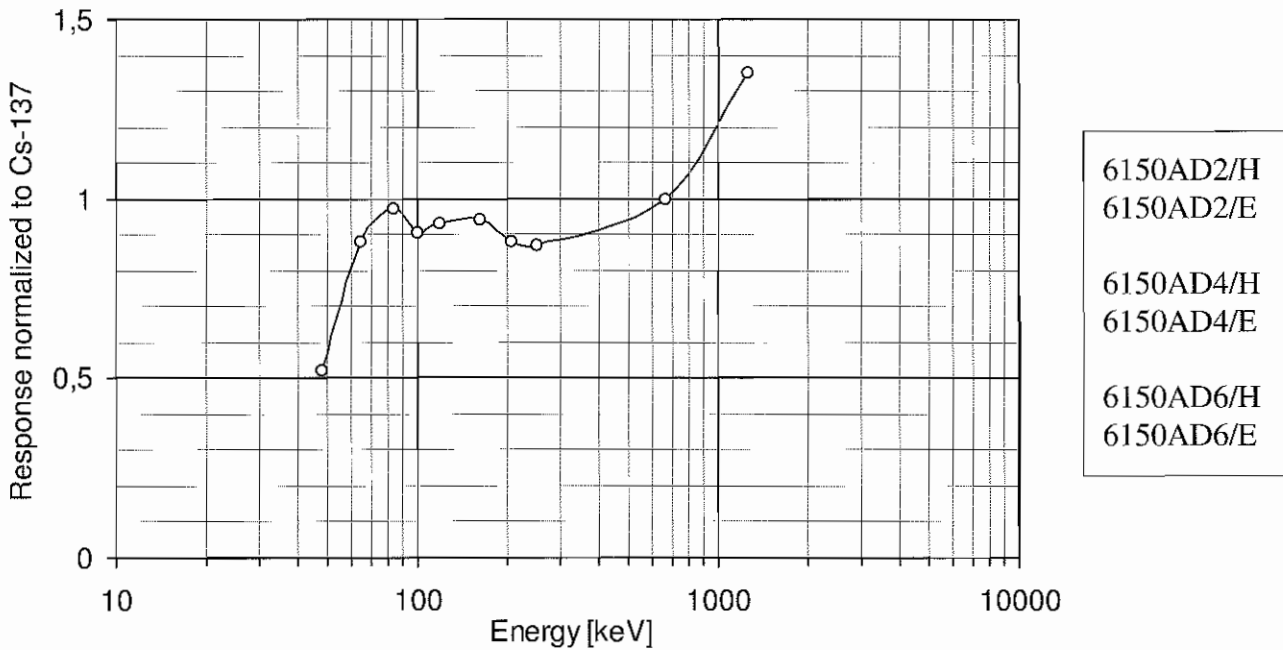

Directional dependence (horizontal rotation) normalized to Cs-137 in preferential direction. The error shall not exceed $\pm 40\%$ for all energies and directions within their nominal ranges:

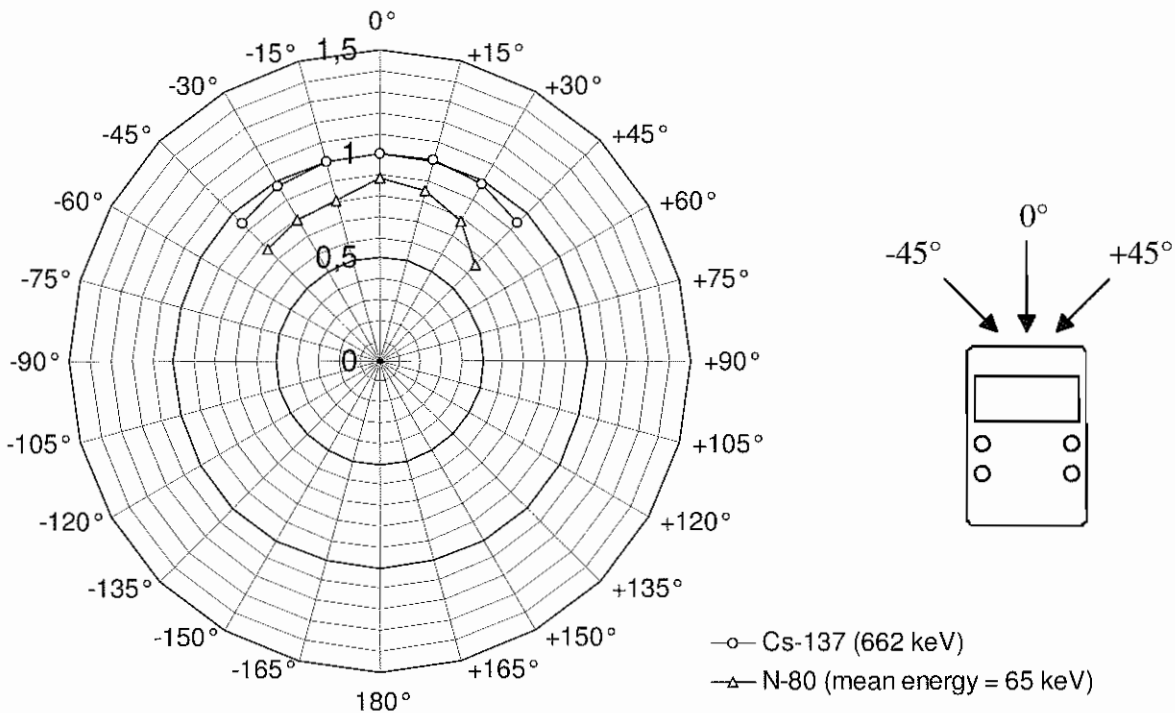

Vertical rotation (rotation around the tube's axis) within an angular range of $\pm 45^\circ$ will change response only by a few percent making a graphical representation unnecessary.

10. Time Constant and Standard Deviation

Just like any other instrument the 6150AD needs a certain integration time to keep the standard deviation to a reasonable limit, that is to prevent dose rate indication from fluctuating too much even under stable conditions. Consequently, if dose rate changes in a sudden step, dose rate indication will not immediately follow that step, but will slowly approach the new value. The time required until the instrument has followed about two thirds of that change is called »time constant« (to be more precise: the time constant is the time it takes until a fraction of $e^{-1} = 0.368$ of the step is remaining). The 6150AD uses a time constant of eight seconds, which provides a fairly stable dose rate indication at reasonable response time (other versions with a floating time constant are also available). Time constant and relative standard deviation of dose rate indication are linked to each other as shown in the diagram below. The x-axis is the pulse rate, and below the x-axis you can find the dose rates of the various detectors corresponding to that pulse rate.

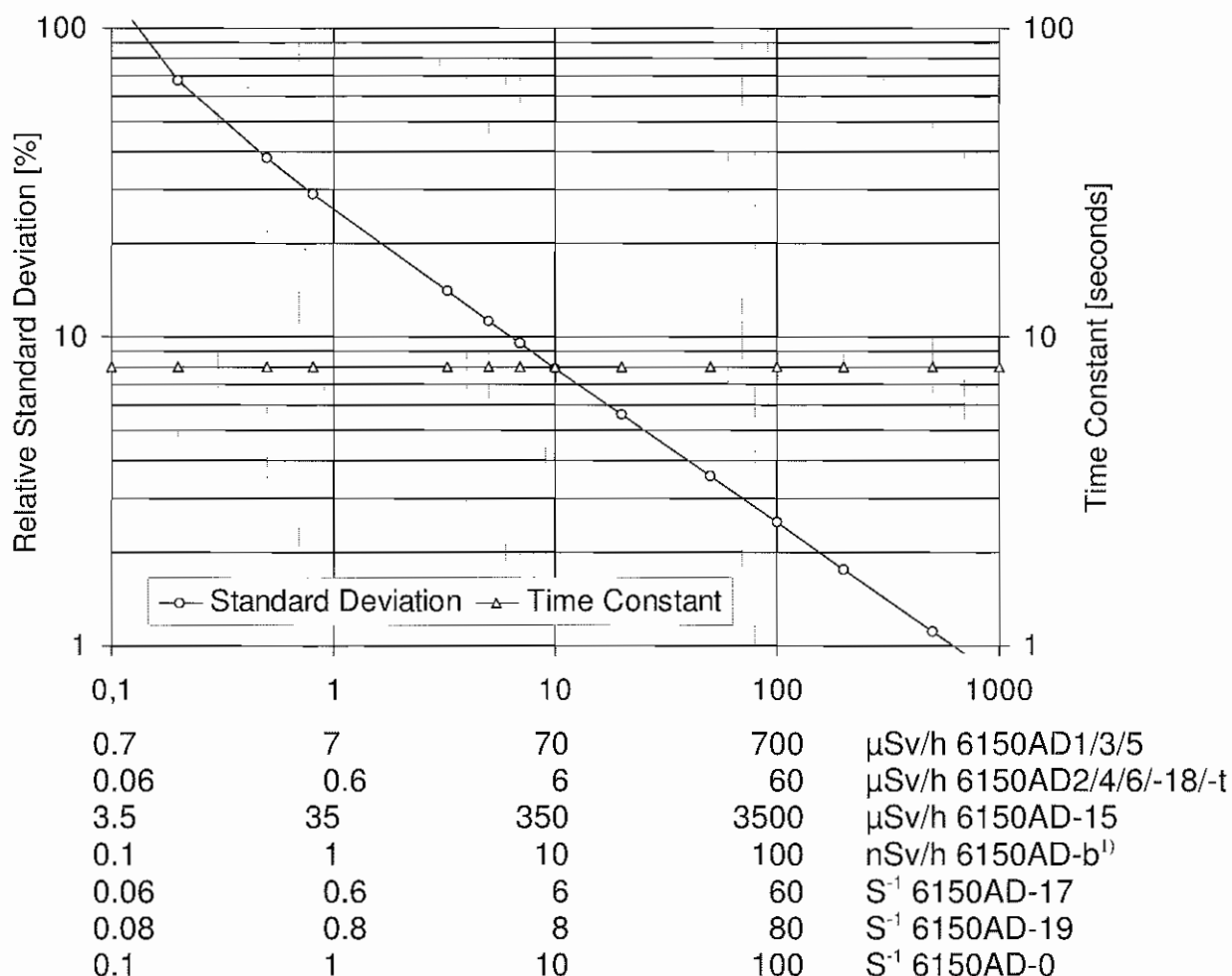

Note, however, that the 6150AD performs more than the diagram suggests. The time constant shown in the diagram only applies to small changes in dose rate. If dose rate changes strongly, the 6150AD turns off its time constant intermediately and jumps to the new value within one or two seconds. After that the time constant will be active again to smooth dose rate indication. You may ask how strong a change in dose rate must be to cause such a fast response. There is no simple answer to that question. It depends on both the initial and the final value of dose rate; a detailed discussion would go beyond the scope of this manual. Just trust the 6150AD's microprocessor that it will make that decision in the best way according to the rules of statistics.

¹⁾ For the Scintillator Probe 6150AD-b, the time constant applies as illustrated, whereas the standard deviation does *not*, because the Scintillator Probe 6150AD-b does not output statistically distributed counting tube pulses like the other detectors do.

11. Radiological Check

You will need the following optional accessories for a radiological check:

- Check source 6706 (nominal activity 333 kBq Cs-137) or equivalent source according to DIN 44427,
- Source holder 761.1 (Other holder types are available for probes, see probe manual).

This equipment allows to expose the 6150AD's internal tube to a well-defined dose rate. In the following we shall call the indication obtained under these conditions a »check reading«. The absolute value of the check reading already gives some information on measuring accuracy. However, the absolute value contains uncertainties like the $\pm 10\%$ tolerance of source activity. But, if you always use the same source and holder for repeated check readings, check readings will not vary by more than a standard deviation of 4%. Consequently, the most accurate method is: use the first check reading as a reference, compare further check readings with that reference, and observe to use always the same source and holder. This method will quickly reveal changes in the 6150AD's accuracy, because it restricts errors to statistical errors and avoids systematic errors like activity tolerance. Of course you should carry out the reference measurement at a time when you know that the instrument is properly calibrated, for example directly after purchasing it.

Follow this procedure to obtain a check reading:

Insert the 6150AD into the holder 761.1 with its front side towards the thread for the check source. Screw the check source into the holder until it touches the marking spot on the front side of the 6150AD. Do not exercise more force than is required just to keep the 6150AD in place. Then switch the 6150AD on and move to dose rate mean value indication by pressing the function key. After a measuring time of at least ten minutes (to ensure sufficient statistical accuracy), take the indicated mean value as the check reading.

NOTE! Conditions have to be stable when measuring the mean value. Consequently, the check source must be in place before the measurement starts! Since measurement starts when the 6150AD is switched on, you have to switch it on after screwing the source into place! If you did not, just switch the 6150AD off and on again to start the measurement once again. With the 6150AD3/4/5/6 you may also clear the mean value using the on/off key.

With a new source the check readings will be approximately:

- 6150AD1/3/5: 155 $\mu\text{Sv/h}$, »/H« and »/E« models: 165 $\mu\text{Sv/h}$
- 6150AD2/4/6: 85 $\mu\text{Sv/h}$, »/H« and »/E« models: 90 $\mu\text{Sv/h}$

You may wonder why the 6150AD1/3/5 values are much higher than the 6150AD2/4/6 values, although in all models the centre of the tube is at the same position. The reason is that the source is very close to the tube, and thus the radiation field across the tube's size is not constant. Indication is a spatial average of the radiation field across the tube's volume, and for the larger tube of the 6150AD2/4/6 this average is only about half of the average across the smaller tube of the 6150AD1/3/5.

NOTE! The check readings just specified are typical values only. Small deviations from these coarse values are normal and must not lead you to the conclusion that the instrument would be miscalibrated!

When comparing two check readings performed at different dates, you have to consider the activity loss of the check source caused by its decay. This is done by multiplying the check reading »R« with a correction factor »c«. The result is the »corrected check reading R_c «. You may only compare check readings corrected to the same reference date. As reference date you may take the date when the source had its nominal activity (usually imprinted on the source), or the date when the reference measurement was performed. In the latter case, the age of the source is irrelevant. The correction factor c depends on

the half-life of the check source (30 years in the case of Cs-137) and the period of time you want to correct for. For Cs-137, you can take the correction factor c as a function of time from the table below.

Example (how to correct for the age of the check source):

age of check source: 5 years => correction factor $c = 1.122$ (see table below)
 check reading R : 75 $\mu\text{Sv/h}$
 corrected check reading R_c : 75 $\mu\text{Sv/h} \cdot 1.122 = 84.15 \mu\text{Sv/h}$

Correction Factor c for Cs-137 (half-life 30.0 years)
 t is the period of time (in years) since the reference date

t / years	c	t / years	c	t / years	c
0.0	1.000				
0.5	1.012	10.5	1.275	20.5	1.606
1.0	1.023	11.0	1.289	21.0	1.625
1.5	1.035	11.5	1.304	21.5	1.643
2.0	1.047	12.0	1.320	22.0	1.662
2.5	1.059	12.5	1.335	22.5	1.682
3.0	1.072	13.0	1.350	23.0	1.701
3.5	1.084	13.5	1.366	23.5	1.721
4.0	1.097	14.0	1.382	24.0	1.741
4.5	1.110	14.5	1.398	24.5	1.761
5.0	1.122	15.0	1.414	25.0	1.782
5.5	1.136	15.5	1.431	25.5	1.803
6.0	1.149	16.0	1.447	26.0	1.823
6.5	1.162	16.5	1.464	26.5	1.845
7.0	1.176	17.0	1.481	27.0	1.866
7.5	1.189	17.5	1.498	27.5	1.888
8.0	1.203	18.0	1.516	28.0	1.910
8.5	1.217	18.5	1.533	28.5	1.932
9.0	1.231	19.0	1.551	29.0	1.954
9.5	1.245	19.5	1.569	29.5	1.977
10.0	1.260	20.0	1.587	30.0	2.000

12. Programming the 6150AD3/4/5/6

You may program the 6150AD3/4/5/6 to meet your individual requirements. Programming is only possible in the programming mode intended especially for this purpose. To enter this programming mode you need to switch the instrument on while the function key and the signal key are pressed. In other words, first press and hold down the function key and the signal key, then press and release the on/off key. After that you may release the function and signal keys. This procedure has intentionally been designed to be somewhat difficult, so that it will prevent users from entering programming mode by chance or by mistake.

During programming mode the instrument does not monitor battery voltage. Therefore it will not enter programming mode if battery voltage is below 5.5 volt, but will switch on normally instead.

The programming mode provides the following functions:

- Programming an individual dose rate alarm threshold,
- Programming an individual dose alarm threshold,
- Programming the post-alarm increment (for dose alarm),
- Enabling or disabling the non-volatile storage of the internal dose,
- Resetting all programmable data to factory setting, and selecting the unit (Sv or R).

Use the function key to move from one function to the next, and use the signal key to select the function to be executed. The flow chart in the appendix gives a quick reference which keys are to be used to perform these functions.

All programmed data are saved in a non-volatile memory and therefore remain valid even after the instrument has been switched off. The non-volatile memory is the same that stores the internal dose; data retention time is at least ten years.

There are two ways to exit programming mode: Either you quit without saving data by pressing and releasing the on/off key and thus switching the instrument off; or you save the indicated data by pressing and holding down the on/off key and then pressing the function key. The instrument confirms the data storage by means of a short sound (0.5 seconds) and then automatically switches itself off.

Note that you can only execute one function from the above list at a time. For example, if you wish to program a dose alarm threshold and the post-alarm increment, you have to enter programming mode twice and execute the appropriate function in each case.

The individual thresholds for dose rate and dose are kept separately for the internal tube and all probe types. If you wish to program an alarm threshold for the internal tube, no probe may be connected before the programming mode is entered. If you wish to program an alarm threshold for some probe type, a probe of that type must be connected before the programming mode is entered. The upper left corner of the LCD shows the probe type as in normal operation. Once you entered programming mode, it is no longer possible to change the probe type since the instrument identifies the probe type only once at the beginning of the programming mode. Therefore it has no effect to connect or disconnect a probe while in programming mode; programming always refers to the detector that was active when entering programming mode. For each of the seven detectors listed below, the instrument provides memory for one dose rate and one dose alarm threshold, which makes a total of 14 thresholds:

1. Internal tube of the 6150AD3/4/5/6,
2. Probe 6150AD-18,
3. Probe 6150AD-15,
4. Probe 6150AD-t,
5. Probe 6150AD-17,
6. Probe 6150AD-19,
7. Probe 6150AD-0, with the 6150AD5/6 also for probe 6150AD-b. Due to lack of space, the 6150AD5/6 has to use this last memory location for both probe types 6150AD-0 and 6150AD-b concurrently. Therefore it is impossible to program different thresholds for those two probe types. If you program the 6150AD-b dose rate alarm threshold to $1 \mu\text{Sv/h}$, then 6150AD-0 probes will have a pulse rate threshold of 1 S^{-1} . Correspondingly, a dose alarm threshold of $1 \mu\text{Sv}$ converts to a pulse count threshold of 1.

Programming functions that are not probe-specific can only be carried out if no probe was connected when entering programming mode. Those functions are: programming the post-alarm increment, enabling the non-volatile storage of the internal dose, and resetting the instrument to factory setting.

Also note that during programming mode the LCD illumination will not remain on for some time after the illumination key is released; it will only be on while that key is depressed.

12.1 Individual Dose Rate Alarm Threshold

Entering programming mode first leads to the individual dose rate alarm threshold. The current value for that threshold is displayed using the same format as during normal operation. The text »OFF« appears if no such threshold is programmed. The text »ProG« flashes simultaneously to indicate that an individual dose rate alarm threshold can now be programmed. The programming mode thus serves not only to modify but also to view programmed data. If you do not wish to modify the threshold, press the function key to move to the next programming function (see next section).

If you wish to modify the threshold, press the signal key. Now you get access to the digits of the threshold that are all preset with zero. The digit to be modified flashes and can be set to a value from 0 to 9 by repeatedly pressing the signal key. Pressing the function key selects the next digit.

The dose rate alarm threshold may be a large number with up to eight digits ($9\,999\,999.9 \mu\text{Sv/h}$). The LCD cannot represent such a large number. Therefore, the eight digits are divided into six window-type parts with three digits each:

	Window position (<u>xxx</u>):	Display:
Window 1:	<u>xxx</u> xxxx, x $\mu\text{Sv/h}$	x, xx Sv/h
Window 2:	x <u>xxx</u> xxx, x $\mu\text{Sv/h}$	xxx mSv/h
Window 3:	xx <u>xxx</u> xx, x $\mu\text{Sv/h}$	xx, x mSv/h
Window 4:	xxx <u>xxx</u> x, x $\mu\text{Sv/h}$	x, xx mSv/h
Window 5:	xxxx <u>xxx</u> , x $\mu\text{Sv/h}$	xxx $\mu\text{Sv/h}$
Window 6:	xxxxx <u>xx, x</u> $\mu\text{Sv/h}$	xx, x $\mu\text{Sv/h}$

You can only modify the current window, that is the three digits currently visible; all invisible digits are zero. The last window (window 6) is available for all detectors. This means that you may set an alarm threshold as low as $0.1 \mu\text{Sv/h}$ for any detector. It is thus your responsibility to observe that the threshold goes well with the beginning of the measuring range of the detector concerned. The first window, however, is not necessarily window 1, but is the one corresponding to the end of the dose rate range of the detector concerned. This automatically prevents setting a threshold exceeding the detector's range.

At the beginning of programming, the most significant digit of the first window is selected and thus flashes. You may adjust that digit using the signal key. Once adjusted, select the next digit by pressing the function key. If the most significant digit is zero, the next digit will be the most significant digit of the next window. In other words, setting the most significant digit to zero and selecting the next digit will also move to the next window. If the most significant digit is non-zero, or if you already are in the last window, pressing the function key will move around the three digits of the current window. It is not possible to go back to a previous window; in that case you need to quit programming mode and restart the procedure.

If you wish to clear (disable) the threshold, set it to zero. For this purpose all three visible digits have to be zero irrespective of the window you are currently in.

In order to store the threshold, press and hold down the on/off key, and then press the function key.

The factory setting for individual dose rate alarm thresholds is »OFF« (disabled).

12.2 Individual Dose Alarm Threshold

This function allows to view and modify the individual dose alarm threshold. If you do not wish to modify that threshold, press the function key to move to the next programming function (see next section).

If you wish to modify the threshold, press the signal key. Now you get access to the digits of the threshold in the same way as for the dose rate alarm threshold (see previous section). The least significant digit of the dose rate alarm threshold is 1 μSv .

The factory setting for individual dose alarm thresholds is »OFF« (disabled).

12.3 Post-alarm Increment for Dose Alarm

This function allows to view and modify the post-alarm increment. The current setting is displayed as follows:

- 2% (= post-alarm in steps of 2%, factory setting),
- or 5% (= post-alarm in steps of 5%),
- or 10% (= post-alarm in steps of 10%),
- or no% (= no dose post-alarm).

The first two digits (2/5/10/no) flash to indicate that they are subject to modification. If you wish to modify the setting, press the signal key repeatedly until the requested value appears. Store the setting by pressing and holding down the on/off key and then pressing the function key.

If you do not wish to modify the setting, press the function key to move to the next programming function (see next section).

The post-alarm increment applies to the dose alarms of the internal tube and all probes.

12.4 Enabling or Disabling non-volatile Dose Storage

This function allows to view and modify dose storage mode. The current setting is displayed as follows:

Stor (= internal dose is stored, factory setting),
 or noSt (= no storage of internal dose, after switching on or disconnecting a probe the dose is always zero).

The messages »Stor« and »no« flash to indicate that they are subject to modification. If you wish to modify the setting, press the signal key accordingly. Store the setting by pressing and holding down the on/off key and then pressing the function key.

If you do not wish to modify the setting, press the function key to move to the next programming function (see next section).

12.5 Resetting to Factory Setting

This function allows to reset all programmable data to factory setting. With some 6150AD models it also allows to select the unit (Sv or R). The display looks as follows:

Sv (= unit is Sv and Sv/h, factory setting),
 rSEt
 or
 R (= unit is R and R/h).
 rSEt

The unit »Sv« or »R« flashes to indicate that it is subject to modification. If you wish to modify the unit, press the signal key accordingly. Store the new unit by pressing and holding down the on/off key and then pressing the function key. Note that this will also reset all data to factory settings and clear the internal dose. It is not possible to change the unit without resetting all other data. That is no considerable restriction, because selecting the unit is subject to national regulations and is usually required only once.

The option to select the unit is not available for H*(10) models (/H and /E models), because H*(10) is always measured in Sv units. With such models this function only serves to reset to factory setting; the display then only shows »rSEt« leaving the unit blank.

The factory settings are summarized below:

- All 14 individual alarm thresholds are set to »OFF«.
- The post-alarm increment is set to 2%.
- The storage mode for the internal dose is set to »Stor«.
- The internal dose is reset to zero.

Note that, when resetting, the internal dose is cleared although the storage mode »Stor« is set simultaneously. The »Stor« mode thus applies to uses following the reset.

13. Wall Holders (Accessories)

Various types of wall holders are available as optional accessories. They allow to store the 6150AD or to use it as a stationary meter.

When operating the 6150AD in a wall holder, for example as a room monitor, you have to consider the following :

- The direction of incidence of the radiation to be measured will not be the preferential direction (which is perpendicular onto the front side), but mostly onto the face with the LCD. Although this different direction will not make a big difference, particularly at higher radiation energies, it means a deviation from the original specification.
- Backscattering effects from the wall may affect the reading.

Currently the following wall holder types are available:

- Wall Holder 761.8: The main purpose of this holder is simply to provide a clear storage place for the 6150AD, for example in a laboratory. If the 6150AD shall be operated in that holder, it must be supplied by its own battery.
- Wall Holder with AC Adapter 761.13: This holder allows to permanently operate the 6150AD from 230V mains instead from its battery. It comprises a standard AC adapter the output of which is connected to a pair of contacts reproducing the shape of a 9V battery. You have to remove the battery cover and the battery to insert the 6150AD into that holder. Once inserted, the 6150AD is automatically connected to the AC adapter.
- Gamma Alarm Station 859.x: This is an electronic device making dose rate alarms better noticeable, for example by a flashlight or a powerful loudspeaker. There are various models differing in output features. Details can be found in the separate operating manuals for that device.
- Probe Multiplexer 861.x: This is also an electronic device allowing to connect several probes to only one 6150AD. The Probe Multiplexer selects the individual probes either automatically, or manually, or according an external computer command. With this device you may monitor several locations with several probes and one central 6150AD. However, that monitoring will not be simultaneously for all locations, but for one location after the other according to a time-slice method. For this device there is also a separate operating manual.

14. Technical Data

14.1 6150AD

	Dose Rate Meter 6150...			
	AD1	AD1/H, AD1/E	AD2	AD2/H, AD2/E
	AD3	AD3/H, AD3/E	AD4	AD4/H, AD4/E
	AD5	AD5/H, AD5/E	AD6	AD6/H, AD6/E
Detector	gamma tube ZP1310 or equivalent, energy compensated, effective length 16 mm, sensitivity at Cs-137 approx. 500 pulses per μSv		gamma tube ZP1210 or equivalent, energy compensated, effective length 40 mm, sensitivity at Cs-137 approx. 5800 pulses per μSv	
Measuring quantity: photon dose (rate) equivalent H_x or ambient dose (rate) equivalent $H^*(10)$	H_x	$H^*(10)$	H_x	$H^*(10)$
Energy dependence: nominal energy range	45 keV to 3 MeV	45 keV to 2.6 MeV	60 keV to 1.3 MeV	
deviation referred to Cs-137	max. $\pm 30\%$		max. $\pm 30\%$	
Directional dependence: nominal angular range	$\pm 45^\circ$ around preferential direction			
deviation referred to preferential direction at the same energy	max. $\pm 20\%$		max. $\pm 20\%$	
Energy and directional dependence, deviation for all energies and directions referred to Cs-137 at preferential direction		max. $\pm 40\%$		max. $\pm 40\%$
Analog dose rate range	1 $\mu\text{Sv/h}$ to 1000 mSv/h		0.1 $\mu\text{Sv/h}$ to 10 mSv/h	
Digital dose rate range	0.0 $\mu\text{Sv/h}$ to 999 mSv/h		0.00 $\mu\text{Sv/h}$ to 9.99 mSv/h	
Instrumental background	< 20 nSv/h		< 20 nSv/h	
Linearity of dose rate measurement	deviation max. $\pm 10\%$, calibration with Cs-137			
Overload: overrange will be indicated up to:	50 Sv/h		500 mSv/h	
Dose rate mean value: digital range (see also sect. 6.2) statistical accuracy	0.000 $\mu\text{Sv/h}$ to 9.999 mSv/h digits flash as long as standard deviation is greater than 5%			
Digital range for dose rate maximum value (see also section 6.4)	6150AD1 (/H, /E): 0 $\mu\text{Sv/h}$ to 999 mSv/h 6150AD3/5 (/H, /E): 0.00 $\mu\text{Sv/h}$ to 999 mSv/h		6150AD2 (/H, /E): 0 $\mu\text{Sv/h}$ to 9.99 mSv/h 6150AD4/6 (/H, /E): 0.00 $\mu\text{Sv/h}$ to 9.99 mSv/h	
Digital dose range (see also section 6.5)	6150AD1 (/H, /E): 0 μSv to 9.99 Sv 6150AD3/5 (/H, /E): 0.00 μSv to 9.99 Sv		6150AD2 (/H, /E): 0 μSv to 99.9 mSv 6150AD4/6 (/H, /E): 0.00 μSv to 99.9 mSv	

	Dose Rate Meter 6150...			
	AD1 AD3 AD5	AD1/H, AD1/E AD3/H, AD3/E AD5/H, AD5/E	AD2 AD4 AD6	AD2/H, AD2/E AD4/H, AD4/E AD6/H, AD6/E
Fixed dose rate alarm thresholds	adjustable to: 25 µSv/h 250 µSv/h 1 mSv/h 2.5 mSv/h 10 mSv/h (no threshold)		adjustable to: 7.5 µSv/h 25 µSv/h 100 µSv/h 2 mSv/h 3 mSv/h (no threshold)	
Fixed dose alarm thresholds	with 6150AD3/5 (/H, /E) adjustable to: 15 mSv 100 mSv 250 mSv (no threshold)		with 6150AD4/6 (/H, /E) adjustable to: 1 mSv 2 mSv (no threshold)	
Programmable alarm thresholds	with 6150AD3/4/5/6 (/H, /E): one additional programmable threshold for both dose rate and dose			
Preferential direction and location of detector	see sketch in section 3.2			
Representation of dose rate	simultaneously in analog and digital form in the LCD, including indication of the unit			
Indication of dose rate mean value, maximum value, dose, and thresholds	digitally in the LCD if requested with function key, including indication of the unit			
Dose rate alarm	audibly through intermittent sound (may be reset), visually through flashing loudspeaker symbol (with /E models, the analog scale divisions additionally flash)			
Dose alarm	with 6150AD3/4/5/6 (/H, /E): audibly through intermittent sound (may be reset), visually through flashing loudspeaker symbol and flashing bar graph			
Audible single pulse detection	yes, may be turned off with signal key			
Display illumination	EL lamp, is turned on with illumination key, continues for ten seconds after releasing the key			
Display test	automatically after switching on while on/off key is pressed			
Temperature range	-30°C to +50°C, deviation max. ±10% referred to indication at +20°C			
Humidity	nominal range 0 to 95% within specified temperature range			
Atmospheric pressure	nominal range 60 to 130 kPa (600 to 1300 mbar)			
Geotropism (change of response as a result of gravitational effects)	none			
Power supply	9V battery (alkaline according to IEC 6LR61 recommended) or 9V accumulator (rechargeable battery)			

	Dose Rate Meter 6150...			
	AD1	AD1/H, AD1/E	AD2	AD2/H, AD2/E
	AD3	AD3/H, AD3/E	AD4	AD4/H, AD4/E
	AD5	AD5/H, AD5/E	AD6	AD6/H, AD6/E
Battery life (with 6LR61): without illumination with illumination	approx. 1000 hours (3000 hours with hardware release 3) approx. 60 hours			
Battery check	voltage is indicated digitally after switching on, or later if requested with the function key			
Supply voltage	nominal range 5.5 to 10 Volt			
Battery monitoring	automatic visual and audible warning if battery voltage drops below 5.5 Volt			
Housing	aluminium die-cast, waterproof, protection class IP 67 according to DIN 40050			
Buzzer	piezo buzzer inside the housing			
Dimensions	130 x 80 x 29 mm ³			
Weight	approx. 400 g			
Carrying strap	plastic, easy to decontaminate, length 1 m			

14.2 Source Holder 761.1

Application	holder to mount check source 6706 onto the 6150AD
Dimensions	150 x 90 x 38 mm ³
Weight	approx. 260 g
Material	grey plastic

14.3 Wall Holder 761.8

Application	wall holder to store the 6150AD
Dimensions	165 x 90 x 45 mm ³ including holding screw
Weight	approx. 330 g including holding screw
Material	grey plastic
Mounting	requires two countersunk screws (not included)

14.4 Wall Holder with AC Adapter 761.13

Application	wall holder with AC adapter for stationary operation of the 6150AD
Dimensions	165 x 90 x 38 mm ³ (excluding AC adapter)
Weight	approx. 370 g (excluding AC adapter)
Material	grey plastic
Mounting	requires two countersunk screws (not included)
AC adapter input	230V~ / 50 Hz / 56 mA / 13 VA
AC adapter output	9 V= / 350 mA
AC adapter cable length	approx. 2 m

14.5 Serial Interface of the 6150AD

This section addresses to users who would like to read and process the dose rate the 6150AD transmits at one-second intervals. For this purpose we shall explain data format in detail.

First please note that the interface's electrical properties (voltage levels) do not exactly meet RS232 specification:

	6150AD output	RS232 output	RS232 input
logical 0 (»space«)	+5V	+5...+15V	> +3V
logical 1 (»mark«)	GND	-5...-15V	< -3V

This means that the 6150AD does not output the logical 1 as a negative voltage, but as ground level. RS232 does not define levels in the range of -3V to +3V, which means it is up to the receiver whether it reads ground level as a logical 0 or 1. However, in practice all PCs read ground level like the negative level, that is as the logical 1. For this reason we decided not to generate a negative voltage for the interface only, which would have meant useless extra effort. Apart from extremely rare exceptions, the 6150AD's non-standard ground level will not cause any problems.

Interface parameters are as follows:

4800 baud, 8 data bits, no parity, 1 start bit, 1 stop bit.

There is no handshaking. For example, if you would like to read the data with a BASIC program through a PC's COM1, use this statement to open the interface:

```
OPEN "com1:4800,n,8,1,rs,cs,ds,cd" FOR INPUT AS #1
```

Format of the transmitted data is binary, which means the data have to be decoded before they can be displayed on the screen. Once per second the 6150AD transmits the following string of six bytes:

1. STX (»start of text«, binary 2) as start character
2. detector in use
3. MLO mantissa of dose rate (low byte)
4. MHI mantissa of dose rate (high byte)
5. EXP exponent of dose rate
6. check sum.

The check sum (last byte) is the XOR (eXclusive OR) of bytes 2 through 5 and serves to detect transmission errors. If the receiver (PC) recognizes a transmission error because the check sum does not fit the preceding bytes, it has to discard the string and wait for the next one. There is no way to ask the 6150AD for a repetition of the last string.

The second byte contains the detector currently in use:

- Bit 7: measuring quantity: 1 = 6150AD »/E« model (6150ADx/E)
0 = other (6150ADx or 6150ADx/H)
- Bit 6: type of internal tube: 0 = ZP1200 (6150AD2/4/6)
1 = ZP1310 (6150AD1/3/5)
- Bit 0-5: detector in use: 0 = probe 6150AD-0
7 = probe 6150AD-b
15 = probe 6150AD-15
17 = probe 6150AD-17
18 = probe 6150AD-18
19 = probe 6150AD-19
20 = 6150AD internal tube
21 = probe 6150AD-t, low range tube
22 = probe 6150AD-t, high range tube

If bit 7 is equal to 1 (6150AD »/E« model), this necessarily means that, if a Sv-probe is connected, that probe will also be a »/E« model, because the 6150ADx/E does not accept other Sv-probes.

Bytes 3 through 5 contain the current dose rate as a floating point number. The unit is always $\mu\text{Sv/h}$, even if the 6150AD is set to R units, and S^{-1} for pulse probes. Dose rate consists of a signed 8-bit exponent on the base of 2 (exponent range -128 to +127) and an unsigned (positive) 16-bit mantissa (range 4000H to 7FFFH, 0000H for zero) with the weight of 2^{-15} . The following BASIC program fragment shows how to convert the three bytes MLO, MHI, and EXP to dose rate DR (in $\mu\text{Sv/h}$ or S^{-1}):

```
IF EXP > 127 THEN EXP = EXP - 256
MANT = MHI * 256 + MLO
DL = MANT * 2^(EXP - 15)
```

The connecting cable EB84-0193 (optional accessory) allows to connect the 6150AD to the serial DB-9 COM port of a standard PC. Since the cable plugs in the 6150AD's probe socket, it blocks that socket for use with a probe. Therefore it has a third connector where a probe may be connected through a standard probe cable. The sketch below explains how to use the cable.

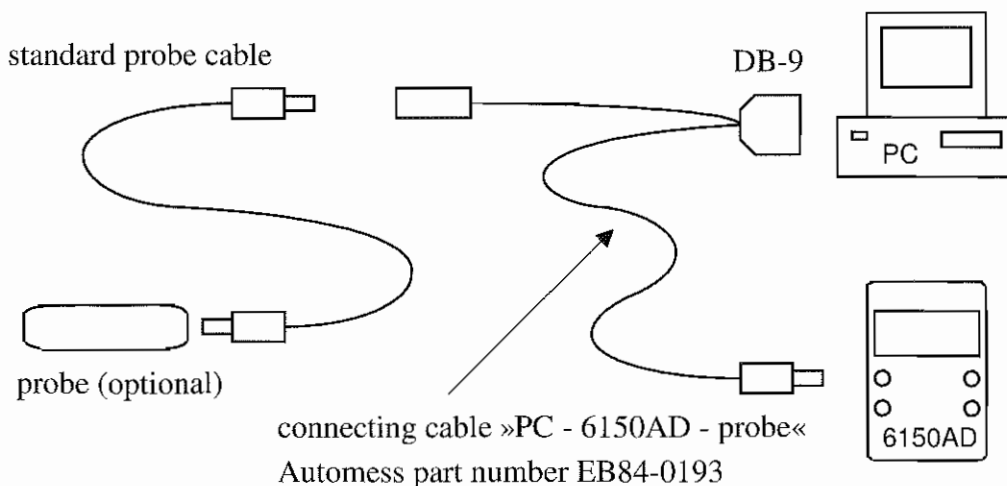

Appendix: 6150AD3/4/5/6 Programming Flow Chart

Start: The instrument is switched off. If alarm thresholds for a probe type are to be programmed, connect probe of that type.

Press + +

Release first, then +

Quit without saving (at any time):
Press and release

No beep, no data are modified, instrument switches itself off.

